

Panasonic

ideas for life

Programmable Controller

FP-X

Strengthened Product Lineup to Meet Diversified Demands



FP-X Programmable Controller
ARCT1B287E '07.5

High Performance, Multiple Functions, and Strengthened Lineup to Support a Wider Variety of Applications

High Performance

High-speed Operation

The 32-bit RISC processor provides the top-level processing speed in compact PLCs. The scan time is 2 ms or less for 5,000 steps*1. A high-speed PLC is indispensable for enhancing the functionality of equipment.

*1 Basic instructions: 40%, Data transfer and operation instructions: 60%



Large Capacity Program Memory

FP-X, which is equipped with 32k steps*2 program memory, is ideal for fully covering the increasing functions, such as communications, positioning, and analog control. The sufficient program capacity can also support future equipment modifications.

*2 C14: 16k steps

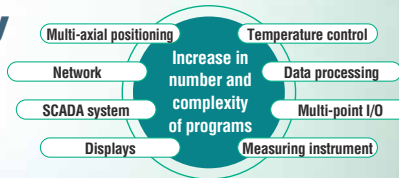

Independent Comment Memory

There are difficulties with program management on a PC, such as identifying the latest program. The use of the program in the PLC of equipment in operation is often regarded as the best option. Since FP-X has an independent comment memory, all comments can be stored in the PLC together with programs, facilitating program management and maintenance.

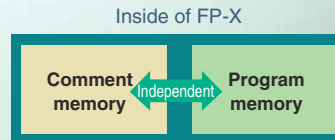

Maximum Number of I/O Points

Since up to eight expansion units can be connected to one control unit, the maximum number of I/O points is 300. Furthermore, with the add-on cassette and expansion FP0 adapter connected, the number of I/O points can be increased to 382.

Network

Up to Three Channels

Three channels are available with a combination of a communication cassette (two-channel type) and the tool port. The combinations of a wide variety of communication functions can support diversified applications.

Ethernet

With a communication cassette (Ethernet type), inspection data, production data, and error information can be easily collected.

Modbus-RTU

Communications with equipment compatible with Modbus-RTU (binary), a worldwide de-facto standard, are available without programming. E.g. temperature controllers and inverters

PLC Link

With a communication cassette (RS485 type), bit data/word data can be easily shared among up to 16 FP-X units.

Computer Link

Easy communications with equipment compatible with Matsushita's open protocol "MEWTOCOL" are available without programming. E.g. displays, image processors, temperature controllers, and power meters

General-purpose Serial Communications

Commands are generated/transmitted in accordance with the communication protocol of the target equipment.
Or, nonprocedural data receiving is available. E.g. measuring instruments, barcode readers, and RF-ID



AFPX-C30R
(Add-on cassette attached)

Programmable Controller

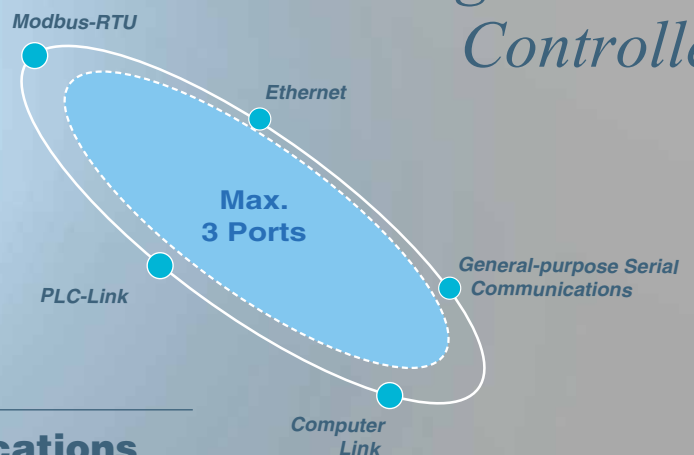

Line Up

Control Unit: 18 Types

(14, 30 or 60 points) × (Relay, NPN or PNP) × (AC or DC)



Expansion Unit: 9 Types

(16 points) × (Relay, NPN or PNP)
(30 points) × (Relay, NPN or PNP) × (AC or DC)



43 Combinations (Number of I/O Points)

14 to 300 points

		Relay output		NPN output		PNP output	
		AC	DC	AC	DC	AC	DC
Control unit	14 points	●	●	●	●	●	●
	30 points	●	●	●	●	●	●
	60 points	●	●	●	●	●	●
Expansion unit	16 points	(Without a power supply section)		(Without a power supply section)		(Without a power supply section)	
	30 points	●	●	●	●	●	●

Add-on Cassette: 16 Types

Digital I/O, Pulse I/O, Analog I/O, Communication
(RS485, RS232C, Ethernet), External memory



Positioning

Built-in 4-axis Pulse Output (Transistor Output Type)

The transistor output type C14 comes with 3-axis while C30/60 comes with 4-axis pulse output built-in the control unit. The multi-axis control, which previously required a higher-level PLC or additional positioning unit, or two or more PLC units, can now be achieved with only one FP-X transistor output type unit in a small space at a low cost. In addition, as this type does not require a pulse I/O cassette needed for a relay output type, other function expansion cassettes such as communication or analog input can be attached for more diversified applications.

FP-X



100kHz x 2 axes

20kHz x 2 axes

XY Table + Processing Head

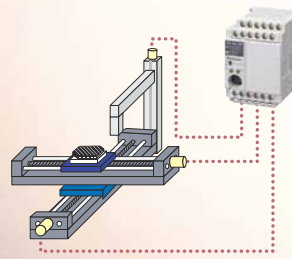

3-axis Control with C14.

Semiconductor Wafer Takeout Blade

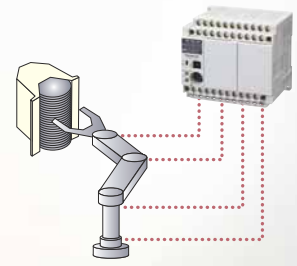



4-axis Control with C30/C60

The Highly Expandable Lineup



Satisfies Wide Range of Demands.

The flexible product lineup designed for rapidly responding to user needs provides a high level of satisfaction.

Product Lineup

Control Unit	Relay output		Transistor output	
	DC power supply	AC power supply	DC power supply	AC power supply
	 <p>Program capacity: 16k steps 2-point potentiometer</p>	<p>AFPX-C14RD</p> <p>8-point input of 24 V DC 6-point output of 2 A relay</p>	<p>AFPX-C14R</p> <p>8-point input of 24 V DC 6-point output of 2 A relay</p>	<p>AFPX-C14TD (NPN) AFPX-C14PD (PNP)</p> <p>8-point input of 24 V DC 0.5 A/5 to 24 V DC 6-point output of transistor</p>
 <p>Program capacity: 32k steps 2-point potentiometer, Equipped with a USB communication port</p>	<p>AFPX-C30RD</p> <p>16-point input of 24 V DC 14-point output of 2 A relay</p>	<p>AFPX-C30R</p> <p>16-point input of 24 V DC 14-point output of 2 A relay</p>	<p>AFPX-C30TD (NPN) AFPX-C30PD (PNP)</p> <p>16-point input of 24 V DC 0.5 A/5 to 24 V DC 14-point output of transistor</p>	<p>AFPX-C30T (NPN) AFPX-C30P (PNP)</p> <p>16-point input of 24 V DC 0.5 A/5 to 24 V DC 14-point output of transistor</p>
 <p>Program capacity: 32k steps 4-point potentiometer, Equipped with a USB communication port</p>	<p>AFPX-C60RD</p> <p>32-point input of 24 V DC 28-point output of 2 A relay</p>	<p>AFPX-C60R</p> <p>32-point input of 24 V DC 28-point output of 2 A relay</p>	<p>AFPX-C60TD (NPN) AFPX-C60PD (PNP)</p> <p>32-point input of 24 V DC 0.5 A/5 to 24 V DC 28-point output of transistor</p>	<p>AFPX-C60T (NPN) AFPX-C60P (PNP)</p> <p>32-point input of 24 V DC 0.5 A/5 to 24 V DC 28-point output of transistor</p>

Expansion Unit	Relay output		Transistor output	
	DC power supply	AC power supply	DC power supply	AC power supply
	 <p>Remarks: Two or more E16 can't be connected serially because it can't supply the power to other units.</p>	<p>AFPX-E16R</p> <p>8-point input of 24 V DC 8-point output of 2 A relay</p>		<p>AFPX-E16T (NPN) AFPX-E16P (PNP)</p> <p>8-point input of 24 V DC 0.5 A/5 to 24 V DC 8-point output of transistor</p>
 <p>Remarks: Addition of up to 8 units is possible including E16 and EFPO.</p>	<p>AFPX-E30RD</p> <p>16-point input of 24 V DC 14-point output of 2 A relay</p>	<p>AFPX-E30R</p> <p>16-point input of 24 V DC 14-point output of 2 A relay</p>	<p>AFPX-E30TD (NPN) AFPX-E30PD (PNP)</p> <p>16-point input of 24 V DC 0.5 A/5 to 24 V DC 14-point output of transistor</p>	<p>AFPX-E30T (NPN) AFPX-E30P (PNP)</p> <p>16-point input of 24 V DC 0.5 A/5 to 24 V DC 14-point output of transistor</p>

Add-on Cassette	Application cassette		Communication cassette		
	NEW				
	AFPX-IN4T3	Input /Output cassette (4-point input of 24 V DC, NPN 0.3 A/3-point output of 24 V DC)		AFPX-COM1	Communication cassette (RS232C 1 ch.)
	AFPX-IN8	Input cassette (8-point input of 24 V DC)		AFPX-COM2	Communication cassette (RS232C 2 ch.)
	AFPX-TR8	Output cassette (NPN 0.3 A/8-point output of 24 V DC)		AFPX-COM3	Communication cassette (RS485/422 selectable 1 ch. insulated)
	AFPX-TR6P	Output cassette (PNP 0.5 A/6-point output of 24 V DC)		AFPX-COM4	Communication cassette (RS485 1 ch. insulated + RS232C 1 ch.)
	AFPX-PLS	Pulse I/O cassette (High-speed counter input: single phase 80 kHz 2 ch., 2-phase 30 kHz 1 ch.) (Pulse output: 1 axis 100 kHz < CW/CCW, pulse + sign >) <i>*Cannot be built into s transistor output type.</i>		AFPX-COM5	Communication cassette (Ethernet 1 ch + RS232C 1 ch.)
	AFPX-AD2	Analog input cassette (2 points, 0 to 10 V/0 to 20 mA 12-bit non-insulated)		AFPX-COM6	Communication cassette (RS485 2 ch. insulated)
AFPX-A21	Analog I/O cassette (Input: 2 ch. (0 to 5 V/0 to 10 V or 0 to 20 mA 12-bit insulated) Output: 1 ch. (0 to 10 V or 0 to 20 mA 12-bit insulated))				
AFPX-DA2	Analog output cassette (2 ch. (0 to 10 V or 0 to 20 mA 12-bit insulated 2 ch.))				
AFPX-TC2	Thermocouple input cassette (K/J type, Resolution: 0.2°C, insulated 2 ch.)				

Expansion FP0 Adapter

AFPX-EFPO

Up to 3 FP0 expansion units can be connected. Please refer to page 7 for details.

FP-X Name and Function of Each Part

Programmable Controller **FP-X**

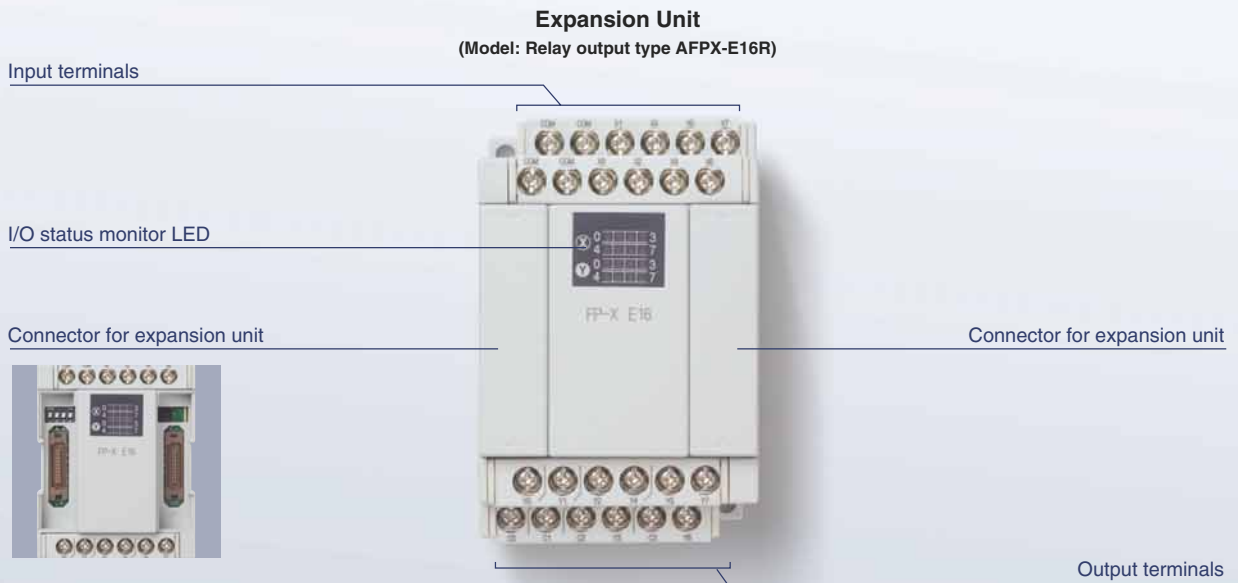
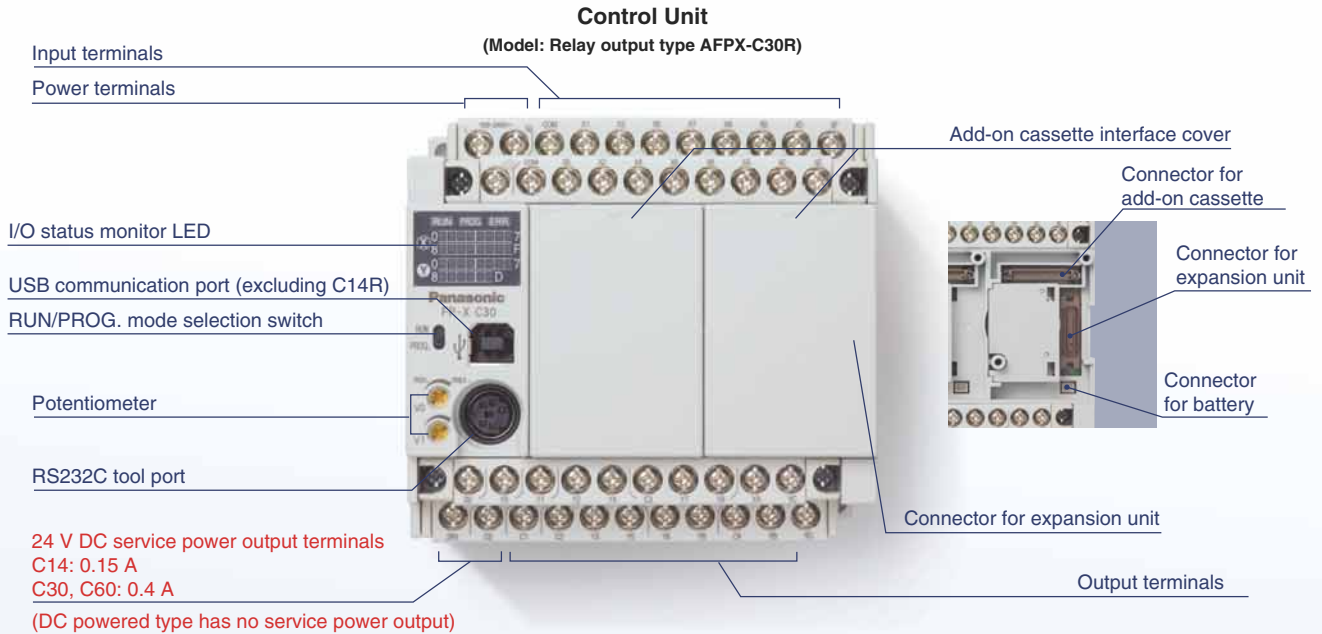

Basic Performance (High capacity/High speed)

Programmable
Controller **FP-X**

The high-level basic performance provides sufficient room for future equipment expansion as well as a rich variation.

■ Abundant program capacity - 32 ksteps (16 ksteps for C14)

The program capacity of 32 ksteps, exceeding the capacity of most compact PLCs, can flexibly handle a wide variety of applications requiring future equipment expansion. An adequate comment area has of course been reserved. Free comment entry makes the program easy to understand during verification.

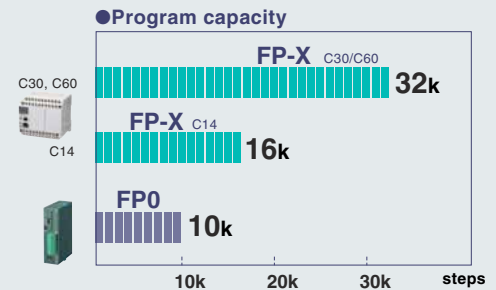

■ Equipped with an independent comment memory

Equipped with an independent comment memory separate from the program memory. All of **100,000** I/O comments, **5,000** lines of line-space comments, and **5,000** lines of remark comments are saved in FP-X together with programs.

*Input comments do not decrease the program capacity.

■ High-speed scan at 0.32 μsec for instruction processing

High-speed processing is often required for small-scale equipment control such as serial data communication, network construction or PID temperature control. High-speed scanning at 0.32 μsec/step (basic instruction) easily meets such requirements.

(Ex.) In the case of a 5-kstep program consisting of 40% basic instructions and 60% applied instructions (Data transfer and operation instructions),

→ Scan time: 1.9 ms (measured time)

● Processing speed of the basic instructions (ST, OR, AND, OT etc)

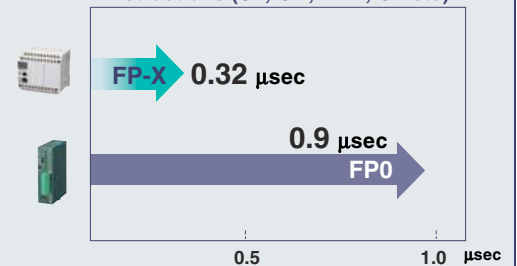

Controls Specifications

Item	Specifications
Program method	Relay symbol method
Control method	Cyclic operation method
Program memory	Flash ROM built-in (no battery backup required)
Program capacity	16 ksteps (C14), 32 ksteps (C30, C60)
Operation processing speed	Basic instruction 0.32 μs/step
Basic instructions	111
Applied instructions	216
External inputs (X)	1760 points *1
External outputs (Y)	1760 points *1
Internal relay (R)	4096 points
Special internal relay (R)	192 points
Link relay (L)	2048 points
Timer/counter (T/C)	Total 1024 points: timer capable of counting (1 ms, 10 ms, 100 ms, 1 s) x 32767 Counter capable of counting 1 to 32767
Data register (DT)	12285 words (C14), 32765 words (C30, C60)
Link data register (LD)	256 words
Special data register (DT)	374 words
Index register (I0 to ID)	14 words
Master control relay (MCR)	256 points
Number of labels (LOOP)	256 labels
Number of differentiations	Up to program capacity
Number of stepladders	1000 stages
Number of subroutines	500 subroutines
Number of interruption programs	Relay output type: 15 programs (14 external, 1 constant) Transistor output type: 9 programs (8 external, 1 constant)
High-speed counter *2	Built-in (Transistor output): single-phase 8 ch (50 kHz x 4 ch + 10 kHz x 4 ch) Built-in (Relay output): single-phase 8 ch (10 kHz x 8 ch) Pulse I/O cassette *3: single-phase 2 ch (80 kHz x 2 ch)

*1 The actual usable number of points is restricted by the hardware.

*2 Specification at the rated input voltage of 24 V DC, 25°C. Frequency may be lower due to the voltage and temperature. The countable frequency also changes depending on the number of channels used.

*3 The pulse I/O cassette cannot be used for the control units (transistor output type).

Item	Specifications
Pulse output *4	Built-in (Transistor output): 100 kHz x 2 ch + 20 kHz x 2 ch Pulse I/O cassette (for the relay output type only): One unit (one axis) 100 kHz, or two units (two axes) 80 kHz
Pulse catch input / interrupt input	Relay output type: Total 14 points (including the high-speed counter) Transistor output type: Total 8 points (including the high-speed counter)
Periodical interrupt	0.5 ms to 30 s
Potentiometer	2 points (0 to 1000) (C14, C30) 4 points (0 to 1000) (C60)
Constant scan	Possible
Real-time clock	Equipped (usable only when AFPX-MRTC is installed) *5
Flash ROM backup *7	Backup by F12, P13 commands Data register (32765 words) Auto-backup at power failure Counter 16 points (1008 to 1023), Internal relay 128 points (R2480 to R255F), Data register 55 words
Battery backup	The memory allocated in the storage area by the system register (only when a battery is installed) *6
Battery life (when no power is supplied)	Before installing AFPX-MRTC C14: 1230 days (actual operation 10 years at 25°C) C30, C60: 990 days (actual operation 10 years at 25°C) After installing AFPX-MRTC C14: 780 days (actual operation 10 years at 25°C) C30, C60: 680 days (actual operation 10 years at 25°C) (More than two batteries can be installed in C30 and C60. In this case, the battery life is extended several times)
Password	Capable (4 or 8 characters selectable)
Self-diagnosis function	Watch dog timer, program syntax check
Comment storage	Capable (328 KB) (backup battery not required) All of I/O comments, remark comments, and line-space comments can be stored.
PLC link function	Max 16 units, link relay 1024 points, link register 128 words (No data transfer or remote programming)
Rewriting in RUN mode	Capable

*4 Max frequency may vary by the method of operation. Please refer to the manual for details.

*5 Calendar accuracy at 0°C: 119 sec/month or less, 25°C: 51 sec/month or less, 55°C: 148 sec/month or less (Real-time clock requires a battery.)

*6 When data is stored in the storage area while the battery is not installed, the data is not cleared and the data value may be indefinite. The same condition occurs when the battery is exhausted.

*7 The number of possible rewrites is 10,000 or less.

Basic Performance (Expansion)

■ Abundant number of I/O points - Maximum 300

(Up to 382 points possible by using FP0 expansion units and add-on cassettes)

When the user cannot predict the number of I/O points required in the future for his machine or equipment, he is uncertain in selecting a PLC model. FP-X solves user concerns with a maximum of 300 I/O channels. The number can even be increased up to 382 points by using the add-on cassettes and FP0 expansion units.

- Expansion units (E16R, E30R, EFP0) can be connected up to eight units.



- Two or more E16 can't be connected serially. ● E16 can be sandwiched with E30*

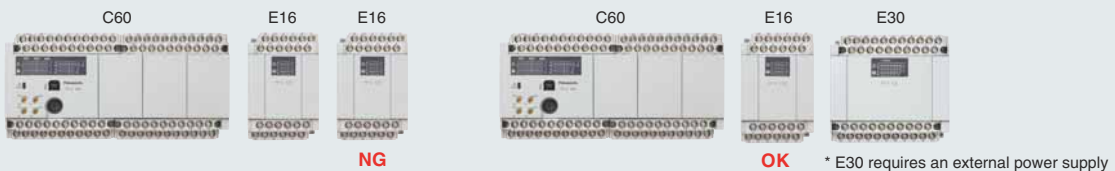

- Connection by using the cable included in each expansion unit.

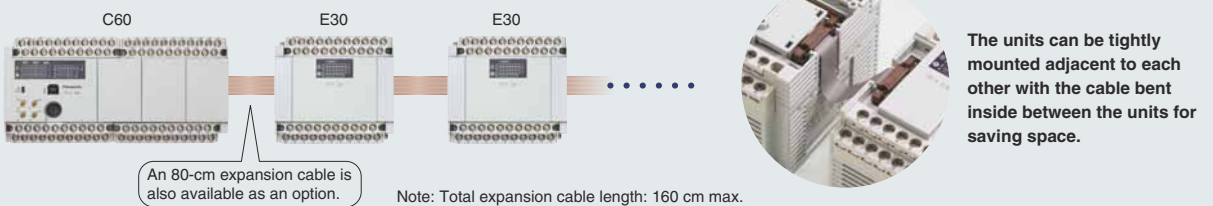

■ When further expansion or functions are required, use the existing FP0 expansion unit.

All control units can be expanded by up to 3 FP0 expansion units via an adapter. Applications can be expanded by using [Transistor outputs], [Analog input/outputs], [Thermocouple input] and [I/O link (network)].

- * Only one expansion FP0 adapter unit can be attached to a control unit. Up to 7 FP-X expansion units can be used when the expansion FP0 adapter is attached.

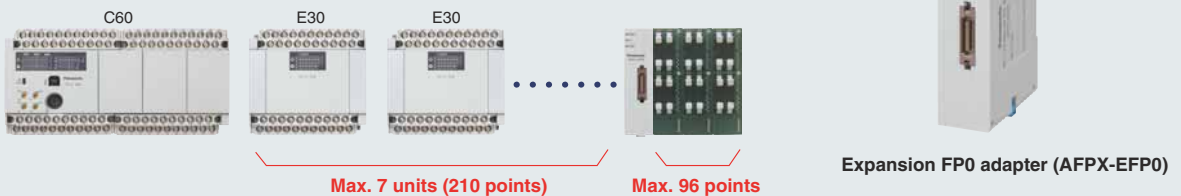

In addition to the supplied 8-cm expansion cable, 30-cm and 80-cm types are available as options, allowing the units to be arranged more freely. (Total expansion cable length: 160 cm max.)

Product number	Specifications	Product number	Specifications
FP0-E8X	8 ch. DC input, MIL connector	FP0-A21	Analog 2 ch. input, 1 ch. output
FP0-E16X	16 ch. DC input, MIL connector	FP0-A80	Analog 8 ch. input
FP0-E8YT	8 ch. transistor output, MIL connector	FP0-A04V	Analog (voltage) 4 ch. output
FP0-E8YRS	8 ch. relay output, screw terminal block	FP0-A04I	Analog (current) 4 ch. output
FP0-E16YT	16 ch. transistor output, MIL connector	FP0-TC4	Thermocouple 4 ch. input
FP0-E32T	16 ch. DC input, 16 ch. transistor output, MIL connector	FP0-TC8	Thermocouple 8 ch. input
FP0-E8RS	4 ch. DC input, 4 ch. relay output, screw terminal block	FP0-IOL	I/O link unit
FP0-E16RS	8 ch. DC input, 8 ch. relay output, screw terminal block	FP0-CCL	CC-link unit
		FP0-E32RS*2	16ch DC input, 16ch relay output screw terminal block
		FP0-RTD6*2	6ch RTD input
		FP0-DPS2*2	PROFIBUS remote I/O unit

We also have other units. Please refer to the part number list at the end of this catalog.

*2 Provided from Panasonic Electric Works Europe AG

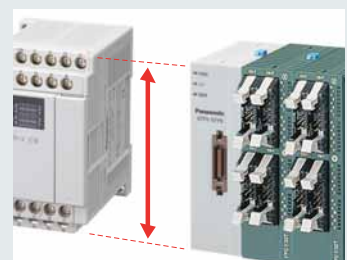

The unified unit height of 90 mm makes the panel surface look clean.

Add-on Cassette (Lineup)

"Require slightly more functions", "Want to add functions to the existing equipment"
 - The rich variety of add-on cassettes helps solve these requirements.

■ The **Add-on cassette** easily adds small quantities of functions and I/O points.

A: Available, N/A: Not available

Add-on Cassette	Part number	Specifications	Attachable position (see the figure below)				
			A, lower	A, upper	B	C	
Application Cassette	I/O cassette	AFPX-IN4T3 NEW	4-point input of 24 V DC, Bi-direction (Sink/Source) 3-point output of 24 V DC, NPN transistor 0.3 A	A	N/A	A	Only a backup battery can be attached.
	Input cassette	AFPX-IN8	8-point input of 24 V DC, Bi-direction (Sink/Source)	A	N/A	A	
	Output cassette	AFPX-TR8	8-point output of 24 V DC, NPN transistor 0.3 A	A	N/A	A	
		AFPX-TR6P	6-point output of 24 V DC, PNP transistor 0.5 A	A	N/A	A	
	Pulse I/O cassette <small>(Cannot be used with a transistor output type control unit.)</small>	AFPX-PLS	High-speed counter input: single phase 80 kHz 2 ch. or 2-phase 30 kHz 1 ch. Pulse output: 1 axis 100 kHz (CW/CCW, Pulse + Sign)	A	N/A	A	
	Analog input cassette	AFPX-AD2	2-point analog input, 0 to 10 V or 0 to 20 mA, 12-bit, 2 ms/2 ch.	A	N/A	A	
	Analog output cassette	AFPX-DA2 NEW	2-point analog output, 0 to 10 V or 0 to 20 mA, 12-bit, 2 ms/2 ch.	A	N/A	A	
	Analog I/O cassette	AFPX-A21 NEW	2-point analog input, 0 to 5 V, 0 to 10 V or 0 to 20 mA, 12-bit, 2 ms/2 ch. 1-point analog output, 0 to 10 V or 0 to 20 mA, 12-bit, 1 ms/1 ch.	A	N/A	A	
	Thermocouple input cassette	AFPX-TC2 NEW	2-point thermocouple input, K/J type, Resolution: 0.2°C, 200 ms/2 ch., Channels insulated	A	N/A	A	
Master memory cassette <small>(Only one cassette can be attached.)</small>	AFPX-MRTC	32 k steps program memory + All comment saving/transfer, Calendar timer (Real-time clock)	A	N/A	A		
Communication Cassette <small>(Only one of these cassettes can be attached.)</small>	AFPX-COM1	RS232C 1 ch.	A	A	N/A		
	AFPX-COM2	RS232C 2 ch.	A	A	N/A		
	AFPX-COM3	RS485/RS422 selectable 1 ch.	A	A	N/A		
	AFPX-COM4	RS485 1 ch. + RS232C 1 ch.	A	A	N/A		
	AFPX-COM5 NEW	Ethernet 1 ch + RS232C 1 ch.	A	A	N/A		
	AFPX-COM6 NEW	RS485 2 ch.	A	A	N/A		

Max. number of attachable cassettes

C14	2 cassettes
C30, C60	3 cassettes



Easily removable
(Two screws to secure the unit)

Attachment position (see the table above)

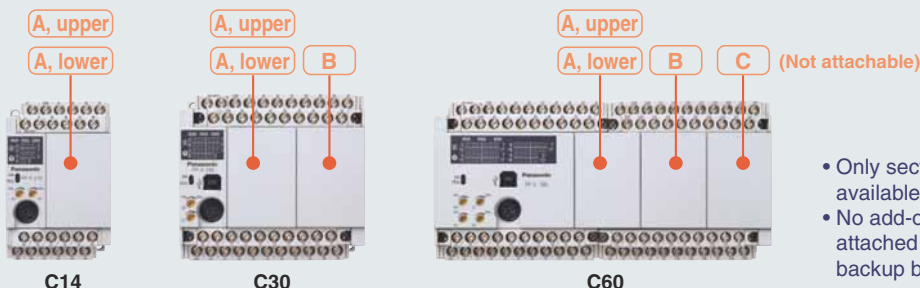

- Only section A has an upper side available to attach the cassette.
- No add-on cassettes can be attached to section C. Only a backup battery can be attached.

Add-on Cassette (Ethernet)

This Ethernet cassette meets user needs such as the "easy collection of inspection/production data using LAN (Ethernet)" or "remote changing of ladder programs".

■ The industry's first*¹ add-on to equip a compact PLC with an Ethernet port

*1: In Japan, as of May 1, 2007

AFPX-COM5

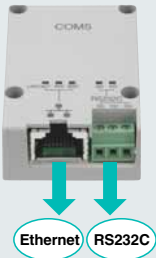

- Enables easy Ethernet connections with a compact PLC, which have been previously abandoned.
- Also equipped with an RS232C port. Together with the tool port (programming port), a total of three communication ports are available, which is remarkable for a compact PLC.
- For example, the following operations are simultaneously available with this cassette attached:
 1. I/O control
 2. Reading data from a tester (measuring instrument) of inspection equipment (RS232C)
 3. Collecting the read data from the host computer (Ethernet)
 4. Setting/monitoring by a touch panel (Tool port)

■ Application

Data collection

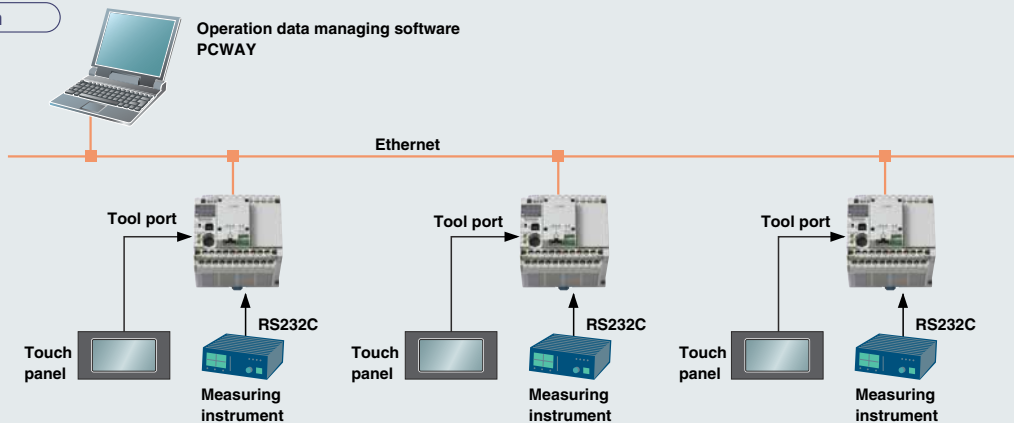

Remote maintenance

Program editing/monitoring

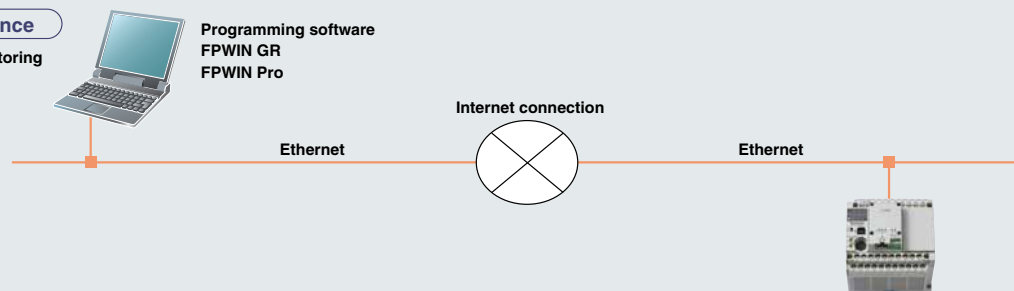

■ Specifications

Interface	Specifications and functions	Ethernet port functions	Specifications
Ethernet (COM1)	10BASE-T, 100BASE-TX, TCP/IP, Baud rate: 9600 bps/115200 bps • Computer link (3 connections max.) • General-purpose serial communications (1 connection max.) → Server function, client function	Computer link	<ul style="list-style-type: none"> • Automatically sends responses without communication programs to commands of Matsushita's open protocol "MEWTOCOL". • Contact/word data writing/reading, program editing • PCWAY, FPWIN GR and FPWIN Pro are supported.
RS232C (COM2)	3-wire (RD, SD, SG), Asynchronous, Baud rate: 300 bps to 115200 bps • Computer link • General-purpose serial communications • Modbus-RTU master/slave	General-purpose serial communications	<ul style="list-style-type: none"> • Waits for a connection from a client PC (personal computer), and after the connection is established, receives data from the PC. • After the power is turned on, establishes a connection to a preset IP address and sends data.

Use our free software "Configurator WD" for setting up the Ethernet port (e.g. IP address and operation mode).

→ Download the software free of charge from:
<http://www.mew.co.jp/ac/e>



FP-X perfectly fits the need for low cost “multi-axis positioning control in small-scale equipment”

Built-in 4-axis Pulse Output (Transistor Output Type)

The transistor output type C14 comes with 3-axis while C30/C60 comes with 4-axis pulse output inside the control unit. The multi-axis control, which previously required a higher-level PLC or additional positioning unit, or two or more PLC units, can now be achieved with only one FP-X transistor output type unit in a small space at a low cost. In addition, as this type does not require a pulse I/O cassette needed for a relay output type, other function expansion cassettes such as communication or analog input can be attached for more diversified applications.

Item	Specification
Pulse Output Max Frequency	C14: 100kHz(CH0,1), 20kHz(CH2) C30,C60: 100kHz(CH0,1), 20kHz(CH2,3)
Output Type	CW/CCW, Pulse + Direction Output
Function	Trapezoidal control, multi-stage operation, jog operation, origin return, 2-axis linear interpolation

● The relay output type can control two axes by using the expansion cassettes

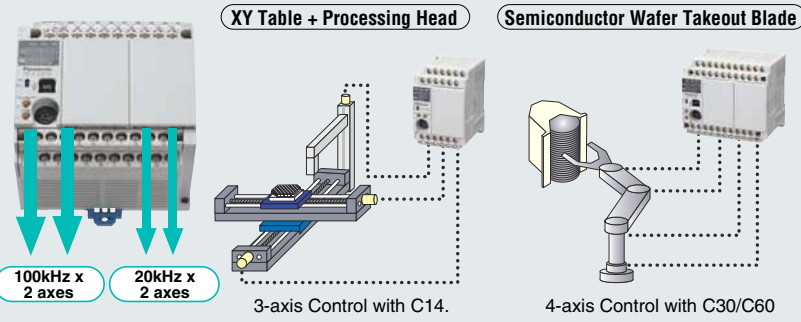

Pulse output up to 2-axis 80kHz is possible by loading two pulse I/O cassettes (AFPX-PLS). Also capable of performing 2-axis linear interpolation.

Remark)
Pulse I/O cassette doesn't work with control unit transistor output type.

2-axis Linear Interpolation Simultaneously in two Sets (Transistor Output Type)

2-axis linear interpolation refers to moving a robot arm or equipment head diagonally on a straight line by simultaneously controlling two motor shafts. It is used for palletizing, component pick and place, XY table control, contour cutting of a PC board etc. FP-X transistor output type is capable of simultaneously controlling 2-axis linear interpolation, for the first time in the industry with a compact pulse-output PLC. This unit drastically expands the range of applications along with the added convenience of programming by using the linear interpolation commands F175 (SPSH).

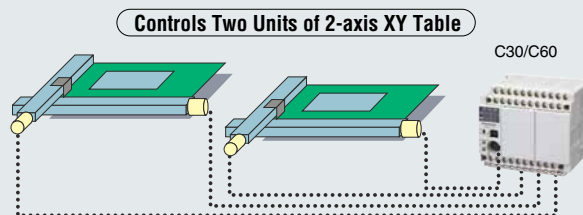
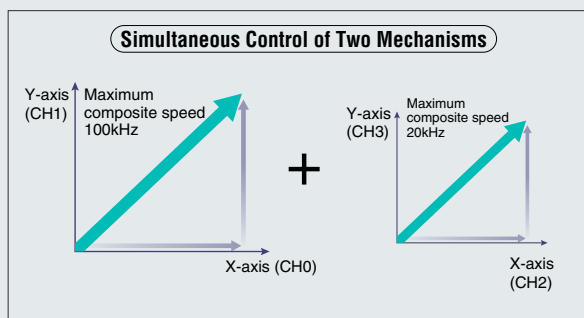

● The relay output type is also capable of 2-axis linear interpolation.

By adding two pulse I/O cassettes (AFPX-PLS), linear interpolation is possible at the maximum composite speed of 80kHz. The command used for this unit is F175 (SPSH), same as that for the transistor output types.

High-Speed Counters – Eight Built-in Sets

Eight single-phase or four dual-phase sets (X0~X7)

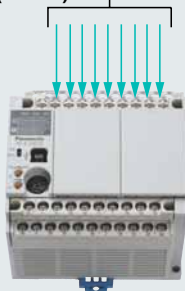

Model Type	Input Mode	Pulse Output (four axes)	One ch in use	All channels in use
Transistor output type	Single Phase	During Halt	100kHz	50kHz × 4ch + 10kHz × 4ch
		During Operation	35kHz	25kHz × 4ch + 10kHz × 4ch
	Dual Phase	During Halt	35kHz	25kHz × 2ch + 5kHz × 2ch
		During Operation	15kHz	10kHz × 2ch + 5kHz × 2ch
Relay output type	Single Phase	During Halt	10kHz	10kHz × 8ch
		During Operation	10kHz	10kHz × 8ch
	Dual Phase	During Halt	5kHz	5kHz × 4ch
		During Operation	5kHz	5kHz × 4ch

When adding a pulse I/O cassette to the relay output type, two high-speed counter sets can be added to every cassette. Please refer to the user manual for counter specification.

Temperature Control

The high-level PID control easily achieves high-speed, high-accuracy multi-point temperature control.

■ New PID Command (F356 EZPID) Produces a Temperature Control Program only in a Single Line.

●The application of PLC-based temperature control has been expanding such as multi-level temperature control, timer-controlled temperature control, and a temperature control relative to a variable based on a data computation results etc. By using the new PID command (F356 EZPID), a PID control program can be drastically simplified and the PLC-based temperature control, which was previously thought to be difficult by a PLC, can easily be achieved. The example on the right, a simple uniform temperature control, enables a surprisingly easily PID control with a single line command by using a F356 command combined with a touch-panel operation.

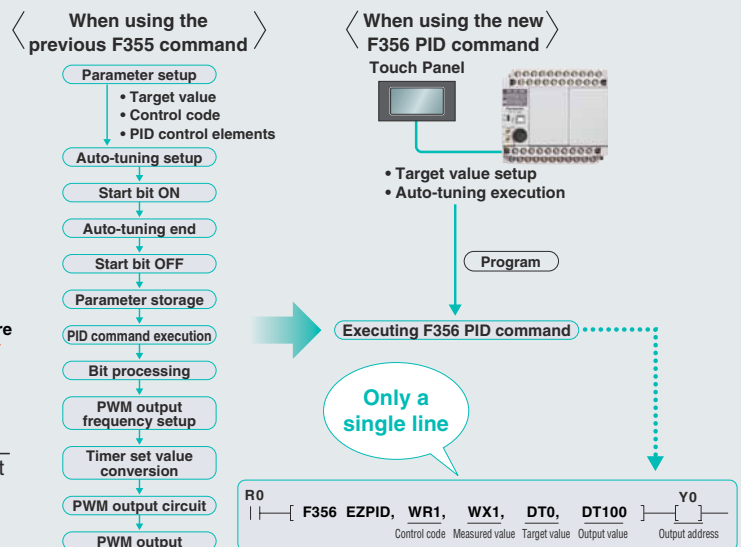
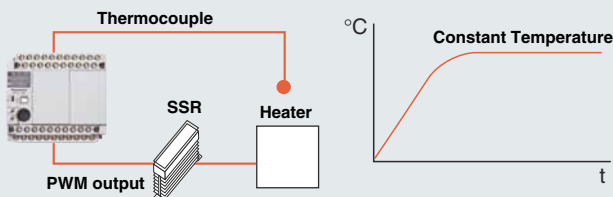

■ Multi-point PID control

- High-accuracy PID control is possible by adopting a sophisticated algorithm and floating-point operations.
 - Higher accuracy is obtained by ultra high-speed computations in a 32 μ s/loop. For example, a 16-loop control only adds a scan time of 0.5 ms by ensuring minimum impact on the tact time.
 - The simultaneous multi-point auto-tuning simplifies complex parameter setting.
 - The high-speed control PI-D*1 mode and overshoot suppression I-PD*2 mode are available for selection according to the intended application.
 - By combining with a sequence control, the parameters (Kp, Ti, Td, etc.) can be changed during a PID control execution, thereby enabling optimum temperature control in each stage including start up, mid-range, and convergence.
- The ability to change the target value easily enables multi-step temperature control, which was difficult only with temperature controllers. In addition, the multi-point temperature control enables the centralized control of multiple temperature controllers with a single FP-X for unified data management.

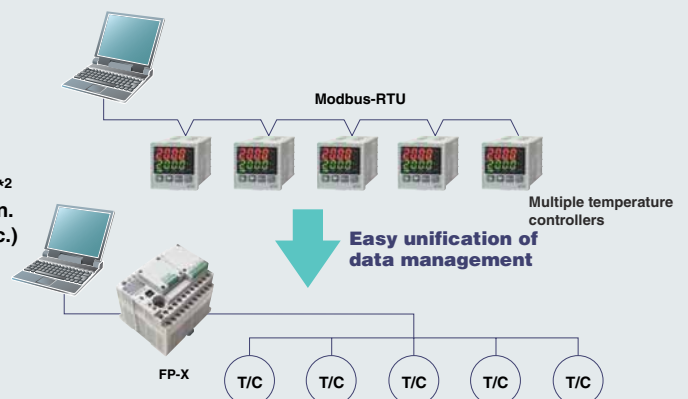

The number can even be increased up to 28 channels by using the thermocouple input cassette and FP0 thermocouple unit.

*1 Derivative type

*2 Proportional-derivative type

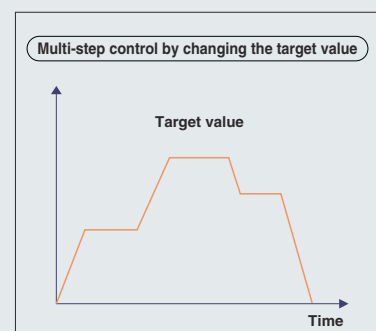
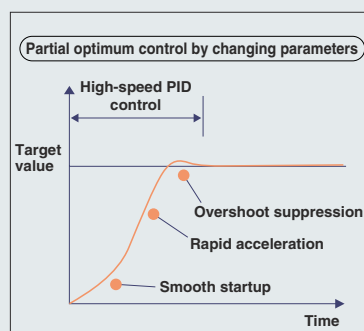
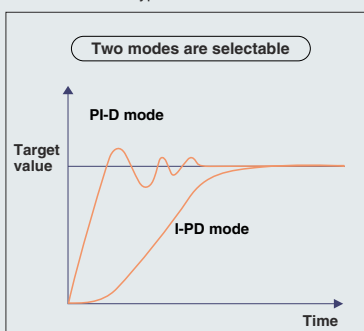

The compact body can be equipped with up to three communication ports, allowing for links to a wide variety of equipment.

■ up to 3 communication ports

With a communication cassette (two-channel type), FP-X can be equipped with up to three communication ports although the body size is small.

The combination of RS232C, RS485, Ethernet, and USB interfaces enables communications with a variety of equipment.

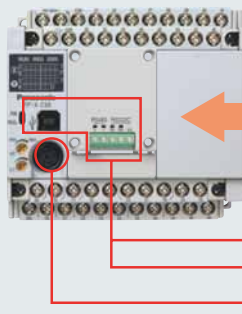

Communication cassette (two-channel type)

- AFPX-COM2 (RS232C + RS232C)
- AFPX-COM4 (RS485 + RS232C)
- AFPX-COM5 (Ethernet + RS232C)
- AFPX-COM6 (RS485 + RS485)

COM1: RS232C, RS485, Ethernet

COM2: RS232C, RS485, USB (The cassette port and the USB port cannot be used simultaneously.)

Tool port: RS232C

■ Ethernet

With an AFPX-COM5 communication cassette (Ethernet type), FP-X data can be easily collected using a host PC through a LAN. This cassette is also equipped with one RS232C channel, also facilitating data collection from a tester (measuring instrument). This is an ideal Ethernet terminal for I/O control.



Data collection

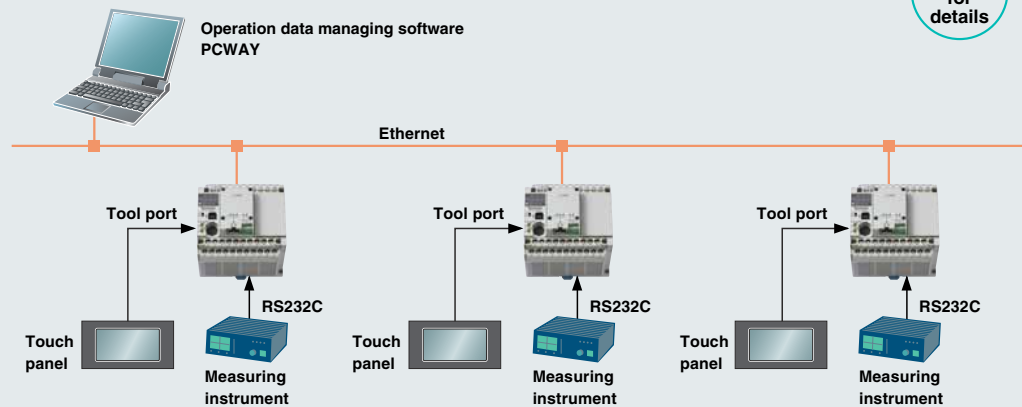

See
page 9
for
details

■ Modbus-RTU* Compatibility

Compatible with both the master and slave of the Modbus* RTU, the world's de-facto standard.

Great performance is expected for air-conditioning, temperature controls etc.

* Protocol developed by the Modicon Inc. of the United States



Usable as a master station [F145 (SEND), F146 (RECV) commands]
Capable of easily communicating with a temperature controller, inverter, FP-e, and foreign PLC

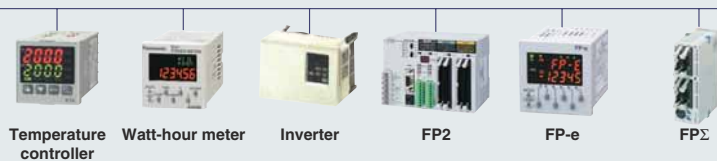

Can also be used as a slave station

Another available application

When 17 or more FP-X units need to be linked, the use of a Modbus instead of a MEWNET-W0 (See following page.) can accommodate up to 99 FP-X units. Because each FP-X can be a master or slave, a multi-master link can be constructed by passing a token from a user program.



■ PLC Link (MEWNET-W0)

Bit data/word data can be shared (linked) among up to 16 FP-X units. This is ideal for linking adjacent equipment in a distributed control system.

- Links with our other PLCs (FP Σ , FP2/FP2SH) are possible.
- Simple setting of the number of linked units, linked relays, and starting area address of the own station by using FPWIN GR/Pro allows sharing of contact information and data without programming.
- The transfer rate of 115.2 kbps, the highest rate for a compact model.
- A transfer distance of 1200 m, the longest distance for a compact model.
- FP-X and FP Σ allow a change of the station number by programming (SYS instruction).

FP-X requires a communication cassette (AFPX-COM3, AFPX-COM4 or AFPX-COM6)

FP2/FP2SH requires a multi-communication unit (AFP2465, AFP2805)

FP Σ requires a communication cassette (AFPG803, AFPG806)

Item	Specifications
Number of stations	16 stations
Transmission speed	115.2 kbps
Transmission distance	1200 m
Shared data	128 words (data register), 64 words (contacts)
Communication method	Floating master

RS485 **16 stations, 115.2 kbps, 1200 m** Twisted-pair cable



■ Computer link (MEWTOCOL slave)

The computer link provides command-response communications using Matsushita's open protocol "MEWTOCOL". When the FP-X communication port is set to the computer link mode, FP-X, as a slave, automatically sends responses to MEWTOCOL commands sent from a master station, such as a personal computer.

FP-X (slave)



Commands

Responses

- Tool port
 - COM1
 - COM2
- All are compatible with the computer link. Simultaneous communications via the three ports are possible.

MEWTOCOL master stations



- Programming software FPWIN GR/FPWIN Pro
- Operation data managing software PCWAY



Touch panel
GT Series



Image processing device
PV310

■ General-purpose Serial Communications

General-purpose serial communications include the following two types.

1. FP-X, as a master, sends commands and receives responses in accordance with the protocol designated by the slave unit.
2. FP-X, as a slave, receives data sent from the master unit as is.

FP-X (master)



Commands

Responses

- Tool port
 - COM1
 - COM2
- All are compatible with general-purpose serial communications. (Tool port: Only in the RUN mode) Simultaneous communications via the three ports are possible.

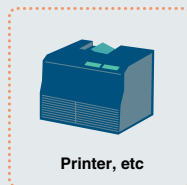

FP-X (slave)



Data (nonprocedural)

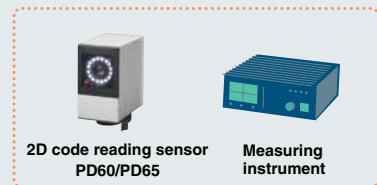

Useful function

When FP-X, as a master, sends commands to MEWTOCOL-compatible equipment during general-purpose serial communications, the commands can be easily generated/transmitted by using the MEWTOCOL master instructions (F145 and F146).

FP-X (master)



MEWTOCOL commands (generated by F145 and F146)

Responses



Other Useful Functions

High versatility and rich functionality provides “peace of mind” and “flexibility”.

- An expensive USB conversion adapter/cable is not necessary for connecting a PC to the PLC by using a standard USB port.*

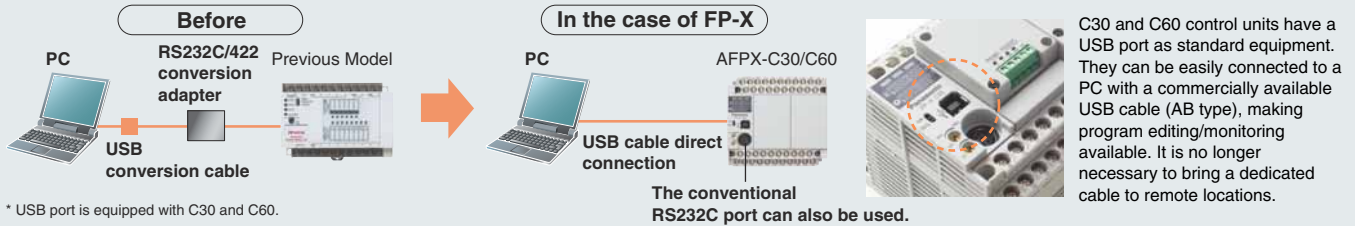

- The master memory makes a program transfer easy and a real-time clock is equipped also

- The built-in 512 KB flash-ROM can store a 32-kstep program as well as the comments and FPCWIN Pro source file.
- Program update in a remote location is easy by simply sending master memory for local installation.
- As the master memory stores the password information, password protection can be applied for program transmission. Similarly, upload prohibition/permission can be setup.
- The built-in real-time clock enables periodical repeated control and periodical data logging.

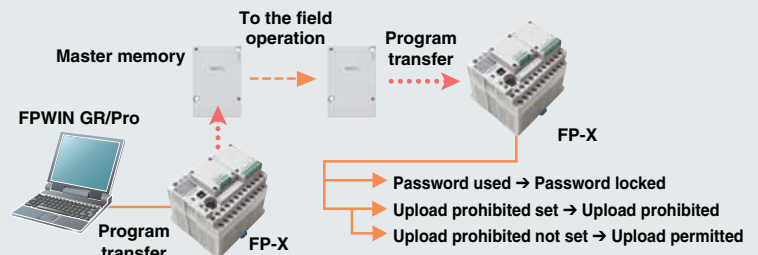

- Programs can be saved without a backup battery, making maintenance easier.

- The programs and comments are stored in flash-ROM, requiring no backup batteries.
- A backup battery (AFPX-BATT) is provided for data and real-time clock.
One battery for C14, two for C30 and three for C60 can be attached. A two-battery installation can operate for a long time (10 years or more) without maintenance. (Real-time clock doesn't work without a battery.)



- F-ROM data saving (Data can be saved without a battery.)

- FP-X can store a program, comments, a total of 55 words of data, and bit setting values in a flash memory without a battery. All of the data and bits can be stored by adding optional batteries, but writing into a flash-ROM is possible without a battery by using applied instructions (F12, P13). Perfectly suited for data storage of the setup values and recipes modified several times a day.

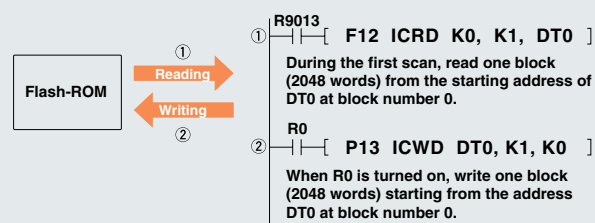

* The limitation in a flash-ROM designates the number of rewrites to be 10,000, or the feasible number to be approx 30,000. However, rewriting every second will generate a memory failure within a few hours.

Other Useful Functions

The enhanced functionality expands the ranges of applications, while improving the ease of use.

■ Securing 0.5A in every transistor output even when all output ports are ON.

The transistor output type is not limited by the control capacity of each common line. Every output port can secure 0.5A even when all output ports are ON for any basic unit C14, C30, C60 as well as the expansion units E16 and E30 (at 25°C) – Sufficient capacity for high-load switching such as LED type signal tower etc.



LED signal tower

Transistor Output Capacity 0.5A
(Even when all output ports are ON)

■ Equipped with a sampling trace function – Smart solution for program debugging

(Available from Ver. 2.0 of the transistor type and relay output types)

The sampling trace function enables the user to monitor a change of I/O condition or data register value in a very short time interval – an efficiency tool for debugging a ladder program.

The shortest sampling interval of the normal time-chart monitor is 10ms with the FPWIN GR or FPWIN Pro, but monitoring in much shorter intervals is often required during debugging operations. The sampling trace function enables data accumulation of any 16 contact data and 3 data register values once or several times within a scan time. Reading out these data through the FPWIN GR or FPWIN Pro enables the user to confirm an instantaneous change of status by time on the time-chart monitor.

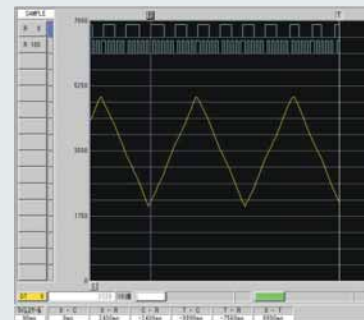

(Normal Time-Chart Monitor)



(Sampling Trace)



Invisible changes become visible!

Protects your important program by preventing illegal copies

■ Program upload is easily prohibited by tool software FPWIN.

- Reading a program from the PLC main unit is virtually impossible.
- In the upload-prohibited condition, program transfers to the master memory are also prohibited.
- Release of an upload-prohibited condition is possible with a forced release accompanied by a program deletion.
- Program updates are easily carried out by transferring the program in the master memory to FP-X even during an upload-prohibited condition. The transferred program in FP-X is setup with the same upload prohibition and permission conditions used in the master memory.



Items possible during an upload-prohibited condition	Program download from a PC Data transfer from the master memory Change of data monitor/resistor value Contact monitor Time chart monitor	Forced input/output (Original program is required) Ladder monitor (Original program is required) Rewrite during RUN mode (Original program is required)
Items impossible during an upload-prohibited condition	Program upload to a PC Data transfer to the master memory	Password protection

■ More secure eight-character password can be used along with the previous four-character password.

- The combination of upper and lower case alphanumeric characters produces 218 trillion combinations. In addition, after three consecutive entry failures, a power reset is required for password release.

Control FPWIN GR for Windows

The ladder programming software for FP series – highly operational software tool for maximizing convenience in the field.

■ Features

1. Easy field operations not requiring the use of a mouse for data entry, search, writing, monitoring and timer changes, all carried out only from the keyboard.
2. Allows standard operations in Windows, such as Copy & Paste, etc.
3. All FP series PLCs are supported. The software assets produced by using Ver. 4 or Ver. 3 of NPST-GR are usable.
4. Easy programming with wizard functions.
5. Communication with CommX, GTWIN, PCWAY simultaneously through the same port.

■ Operational Environment

OS	Windows95 (OSR2 or higher)/98/Me/NT (Ver. 4.0 or later)/2000/XP
Hard disk capacity	At least 40 MB
CPU	Pentium 100 MHz or higher
Onboard memory	At least 64 MB (depends on OS)
Screen resolution	At least 1024 × 768
Display colors	High color (16-bit or higher)
Applicable PLC	FP-X/FP-e/FP0/FPΣ/FP2/FP2SH
Compatible FP-X version	Relay output type: Ver.2.50 and after Transistor output type: Ver.2.70 and after

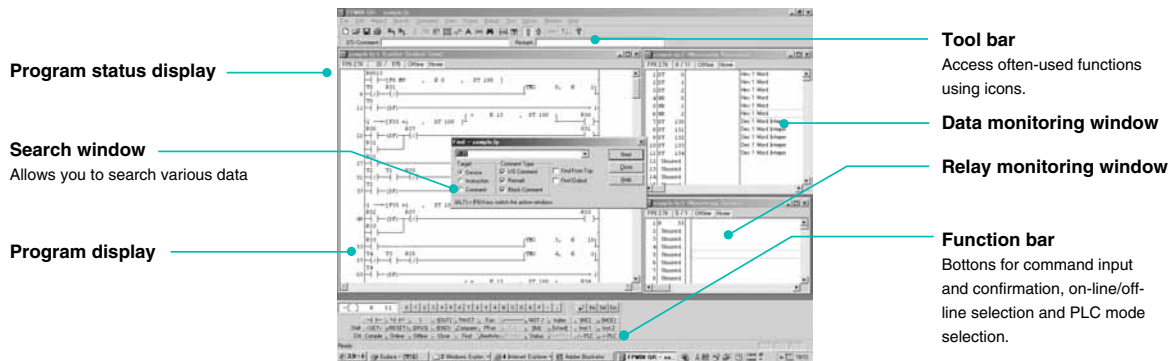

Function instruction list



Classified by type, function instructions can be selected from the displayed list. (Simple help included.)

Text Compiler



This software is for importing and exporting programs created in text format to and from FPWIN GR. Programs created on the PLC of another company can be edited as text and then be transferred to the FP Series without difficulty.

I/O comment edit function

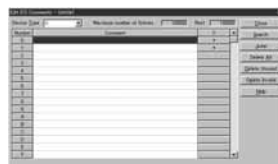

Successive I/O comments can be input for each device type. Data from Excel and other applications can be copied and pasted via the clipboard.

Text command input mode



Text command input mode

A ladder diagram is displayed as a mnemonic code is entered from the keyboard.

Status display



Displays information concerning PLC usage situation and settings, and detailed information when an error occurs.

■ Accompanying Tools

● Data Editor

This software for the PC is for reading and writing data stored in the memory of FP Series main unit or on an IC card. If a large data table is required in a PLC, the data can be created and edited on a PC and then download to the PLC.

● Modem connection

Communication via modem is easy with FP Series units in isolated locations.

● Wizard function

A Wizard function included in FPWIN GR since versions 2.2 can automatically generate ladder programs by simply entering and selecting required items in the dedicated screen. It can be used to assist in positioning, PID instruction input, and FP-e screen display instruction input.

● Personal preference settings

It is possible to switch among preference settings for FPWIN GR, Data Editor and Text Compiler that are set up for different individuals.

Programming

Programmable Controller **FP-X**

Note: Product names and company names in this chart are trademarks or registered trademarks of the respective companies.

Control FPWIN Pro (IEC61131-3 compliant Windows version software)

Compliant with international standard IEC61131-3
Programming software approved by PLC Open

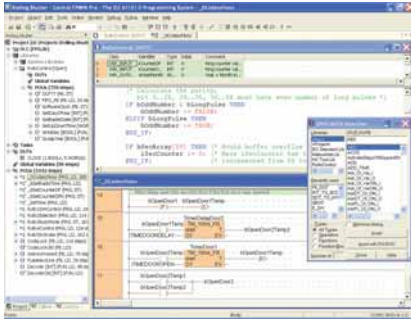
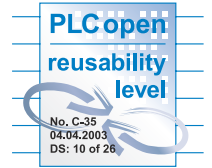

■ Features

1. Five programming languages can be used.

Programming can be done using the language most familiar to the developer or using the language most suited to the process to be performed. High-level (structured text) languages that allow structuring, such as C, are supported.

2. Easy to reuse well-proven programs

Efficiency when writing programs has been greatly increased by being able to split programming up for each function and process using structured programming.

3. Keep know-how from getting out

By "black boxing" a part of a program, you can prevent know-how from leaking out and improve the program's maintainability.

4. Conversion function for previously written programs provided to allow use of program assets.

5. Uploading of source programs from PLC possible.

Maintainability increased by being able to load programs and comments from the PLC.

* This only applies to FP-X, FPΣ and FP2 (with comment memory) and to FP2SH and FP10SH (with card board).

6. Programming for all models in the FP series possible.

Any model can be used.

■ Programming in the most suitable language

● Programming in the language most suited to the process

Easy-to-understand, efficient programs can be created, for example, by using a ladder program for machine control or ST for communications control.

● Programming in the language you are good at

Programming time can be greatly reduced by the easy ability to split and then integrate programming for each function and process.

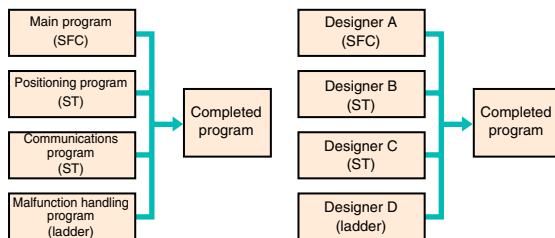

■ "Black boxing" of programs

● Multiple passwords for protection of each block

The security level (8 levels) can be input for each block in a program. Only users of a set security level or higher can make changes.

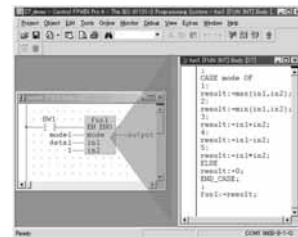
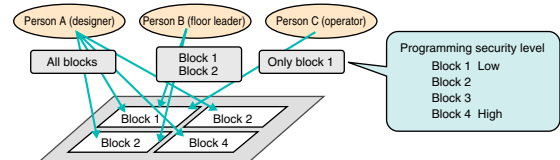

■ Reuse of programs is easy.

● Register time-proven programs by block in the library.

● By using variable identifiers (names), there is no need to be concerned with addresses for each machine when reusing programs.

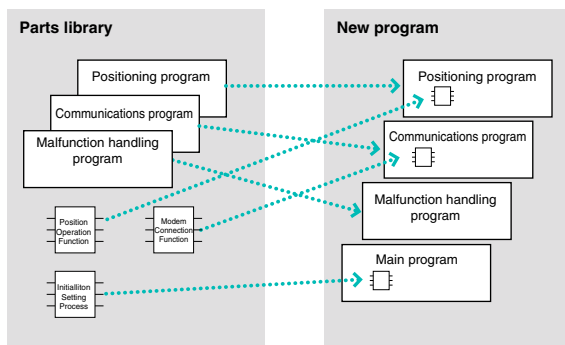

■ Operational Environment

OS	Windows95 (OSR2 or higher)/98/Me/NT (Ver. 4.0 or later)/2000/XP
Hard disk capacity	At least 100 MB
CPU	Pentium 100 MHz or higher
Onboard memory	At least 64 MB (depends on OS)
Screen resolution	At least 1024 × 768
Display colors	High Color (16-bit) or higher
Applicable PLC	FP-X/FP-e/FP0/FPΣ/FP1/FP-M/FP2/FP2SH/FP3/FP10SH
Compatible FP-X version	Relay output type: Ver.5.1 and after Transistor output type: Ver.5.3 and after

Part Number List

Programmable
Controller **FP-X**

FP-X Control Unit

N/A: Not available
A: Available

	Product name	Power supply	Specifications	Program capacity	Potentiometer	USB port	Part number
Relay output	FP-X C14R	100 to 240V AC	8-point input of 24 V DC, 6-point output of 2 A relay	16k steps	2-point	N/A	AFPX-C14R
	FP-X C14RD	24V DC	8-point input of 24 V DC, 6-point output of 2 A relay	16k steps	2-point	N/A	AFPX-C14RD
	FP-X C30R	100 to 240V AC	16-point input of 24 V DC, 14-point output of 2 A relay	32k steps	2-point	A	AFPX-C30R
	FP-X C30RD	24V DC	16-point input of 24 V DC, 14-point output of 2 A relay	32k steps	2-point	A	AFPX-C30R
	FP-X C60R	100 to 240V AC	32-point input of 24 V DC, 28-point output of 2 A relay	32k steps	4-point	A	AFPX-C60R
	FP-X C60RD	24V DC	32-point input of 24 V DC, 28-point output of 2 A relay	32k steps	4-point	A	AFPX-C60RD
Transistor output	FP-X C14T	100 to 240V AC	8-point input of 24 V DC, 0.5 A/5 to 24 V DC, 6-point output of transistor (NPN)	16k steps	2-point	N/A	AFPX-C14T
	FP-X C14TD	24V DC	8-point input of 24 V DC, 0.5 A/5 to 24 V DC, 6-point output of transistor (NPN)	16k steps	2-point	N/A	AFPX-C14TD
	FP-X C14P	100 to 240V AC	8-point input of 24 V DC, 0.5 A/24 V DC, 6-point output of transistor (PNP)	16k steps	2-point	N/A	AFPX-C14P
	FP-X C14PD	24V DC	8-point input of 24 V DC, 0.5 A/24 V DC, 6-point output of transistor (PNP)	16k steps	2-point	N/A	AFPX-C14PD
	FP-X C30T	100 to 240V AC	16-point input of 24 V DC, 0.5 A/5 to 24 V DC, 14-point output of transistor (NPN)	32k steps	2-point	A	AFPX-C30T
	FP-X C30TD	24V DC	16-point input of 24 V DC, 0.5 A/5 to 24 V DC, 14-point output of transistor (NPN)	32k steps	2-point	A	AFPX-C30TD
	FP-X C30P	100 to 240V AC	16-point input of 24 V DC, 0.5 A/24 V DC, 14-point output of transistor (PNP)	32k steps	2-point	A	AFPX-C30P
	FP-X C30PD	24V DC	16-point input of 24 V DC, 0.5 A/24 V DC, 14-point output of transistor (PNP)	32k steps	2-point	A	AFPX-C30PD
	FP-X C60T	100 to 240V AC	32-point input of 24 V DC, 0.5 A/5 to 24 V DC, 28-point output of transistor (NPN)	32k steps	4-point	A	AFPX-C60T
	FP-X C60TD	24V DC	32-point input of 24 V DC, 0.5 A/5 to 24 V DC, 28-point output of transistor (NPN)	32k steps	4-point	A	AFPX-C60TD
	FP-X C60P	100 to 240V AC	32-point input of 24 V DC, 0.5 A/24 V DC, 28-point output of transistor (PNP)	32k steps	4-point	A	AFPX-C60P
	FP-X C60PD	24V DC	32-point input of 24 V DC, 0.5 A/24 V DC, 28-point output of transistor (PNP)	32k steps	4-point	A	AFPX-C60PD

Note: The 24 V DC inputs of all units are bi-directional (sink/source) inputs.

FP-X Expansion Unit

	Product name	Power supply	Specifications	Part number
Relay output	FP-X E16R Expansion I/O unit	— (Power is supplied from the left-side unit.)	8-point input of 24 V DC, 8-point relay output of 2 A Remarks; Two or more E16R can't be connected serially because it can't supply the power to other units. With an 8cm extension cable	AFPX-E16R
	FP-X E30R Expansion I/O unit	100 to 240V AC	16-point input of 24 V DC, 14-point relay output of 2 A Remarks; Possible to connect up to 8 units including E16R, EFPO. With an 8cm extension cable	AFPX-E30R
	FP-X E30RD Expansion I/O unit	24V DC	16-point input of 24 V DC, 14-point relay output of 2 A Remarks; Possible to connect up to 8 units including E16R, EFPO. With an 8cm extension cable	AFPX-E30RD
Transistor output	FP-X E16T Expansion I/O unit	— (Power is supplied from the left-side unit.)	8-point input of 24 V DC, 8-point transistor (NPN) output of 0.5 A Remarks; Two or more E16T cannot be connected serially because it cannot supply the power to other units. With an 8cm extension cable	AFPX-E16T
	FP-X E16P Expansion I/O unit	— (Power is supplied from the left-side unit.)	8-point input of 24 V DC, 8-point transistor (PNP) output of 0.5 A Remarks; Two or more E16T cannot be connected serially because it cannot supply the power to other units. With an 8cm extension cable	AFPX-E16P
	FP-X E30TD Expansion I/O unit	24V DC	16-point input of 24 V DC, 14-point transistor (NPN) output of 0.5 A Remarks; Possible to connect up to 8 units including E16, EFPO. With an 8cm extension cable	AFPX-E30TD
	FP-X E30T Expansion I/O unit	100 to 240V AC	16-point input of 24 V DC, 14-point transistor (NPN) output of 0.5 A Remarks; Possible to connect up to 8 units including E16, EFPO. With an 8cm extension cable	AFPX-E30T
	FP-X E30PD Expansion I/O unit	24V DC	16-point input of 24 V DC, 14-point transistor (PNP) output of 0.5 A Remarks; Possible to connect up to 8 units including E16, EFPO. With an 8cm extension cable	AFPX-E30PD
	FP-X E30P Expansion I/O unit	100 to 240V AC	16-point input of 24 V DC, 14-point transistor (PNP) output of 0.5 A Remarks; Possible to connect up to 8 units including E16, EFPO. With an 8cm extension cable	AFPX-E30P
	Expansion FP0 Adapter	24V DC	Up to 3 FP0 expansion units can be connected via an adapter. With an 8cm extension cable and power cable	AFPX-EFP0

Note: The 24 V DC inputs of all units are bi-directional (sink/source) inputs.

Part Number List

FP-X Add-on Cassette

Product name	Specifications	Part number
FP-X Input /Output cassette	4-point input of 24 V DC, bi-directional (sink/source), 3-point output of NPN transistor 0.3 A/24 V DC	AFPX-IN4T3
FP-X Input cassette	8-point input of 24 V DC, bi-directional (sink/source)	AFPX-IN8
FP-X Output cassette	8-point output of NPN transistor, 0.3 A/24 V DC	AFPX-TR8
	6-point output of PNP transistor, 0.5 A/24 V DC	AFPX-TR6P
FP-X Pulse I/O cassette	High-speed counter input: single-phase 2 ch., each 80 kHz or two-phase 1 ch., 30 kHz, Pulse output: one axis 100 kHz/ch. (Use restriction is applied for a two-unit installation) Cannot be used with a transistor output type control unit.	AFPX-PLS
FP-X Analog input cassette	2-point analog input, 0 to 10 V/0 to 20 mA, 12-bit, 2 ms/2 ch. (non-insulated)	AFPX-AD2
FP-X Analog output cassette	2-point analog output, 0 to 10 V/0 to 20 mA, 12-bit, 2 ms/2 ch. (insulated)	AFPX-DA2
FP-X Analog I/O cassette	2-point analog input, 0 to 5 V/0 to 10 V or 0 to 20 m, 12-bit, 2 ms/2 ch., 1 point analog output, 0 to 10 V or 0 to 20 m, 12-bit, 1 ms/1 ch. (insulated)	AFPX-A21
FP-X Thermocouple input cassette	2-point thermocouple input, K/J type, Resolution: 0.2°C, 200 ms/2 ch. Channels insulated	AFPX-TC2
FP-X Master memory cassette with a real-time clock	Master memory: Capable of storing all program steps and comments simultaneously. Storage of FPWIN Pro source files Real-time clock: Year, month, day, hour, minute, second, day of week (optional battery required)	AFPX-MRTC
FP-X COM1 Communication cassette	RS232C 1 ch. RS and CS control signal equipped (non-insulated)	AFPX-COM1
FP-X COM2 Communication cassette	RS232C 2 ch. (non-insulated)	AFPX-COM2
FP-X COM3 Communication cassette	RS485/RS422 selectable 1ch (insulated)	AFPX-COM3
FP-X COM4 Communication cassette	RS485 1 ch. (insulated) + RS232C 1 ch. (non-insulated)	AFPX-COM4
FP-X COM5 Communication cassette	Ethernet 1 ch. (10BASE-T, 100BASE-TX) + RS232C 1 ch. (non-insulated)	AFPX-COM5
FP-X COM6 Communication cassette	RS485 2 ch. (insulated)	AFPX-COM6

FP-X Options and Service Parts

Product name	Specifications	Part number
FP-X Backup battery	Battery for backing up the operation memory and real-time clock	AFPX-BATT
FP-X Expansion cable	Expansion unit connection cable, 8 cm	AFPX-EC08
	Expansion unit connection cable, 30 cm	AFPX-EC30
	Expansion unit connection cable, 80 cm	AFPX-EC80
FP-X Terminal block	Terminal block for C30, C60 and E30, 21 pins, cover with no marking, four units included	AFPX-TAN1

Related Products List

FP0 Expansion Units

Product name	Specifications						Product number	Part number
	Number of I/O points	Power supply voltage	Input	Output	Connection type			
FP0 E8 Expansion Unit	8	Input: 8	-	24 V DC Sink/Source (±common)	-	MIL connector	FP0-E8X	AFP03003
	8	Input: 4 Output: 4	24 V DC	24 V DC Sink/Source (±common)	Relay output: 2 A	Terminal block	FP0-E8RS	AFP03023
	8	Output: 8	24 V DC	-	Relay output: 2 A	Molex connector	FP0-E8RM	AFP03013
	8	Output: 8	-	-	Relay output: 2 A	Terminal block	FP0-E8YRS	AFP03020
FP0 E16 Expansion Unit	16	Input: 16	-	24 V DC Sink/Source (±common)	-	MIL connector	FP0-E16X	AFP03303
	16	Input: 8 Output: 8	24 V DC	24 V DC Sink/Source (±common)	Relay output: 2 A	Terminal block	FP0-E16RS	AFP03323
	16	Input: 8 Output: 8	-	24 V DC Sink/Source (±common)	Transistor output: NPN 0.1 A/5 to 24 V	Molex connector	FP0-E16RM	AFP03313
	16	Output: 16	-	-	Transistor output: NPN 0.1 A/5 to 24 V	MIL connector	FP0-E16T	AFP03343
FP0 E32 Expansion Unit	32	Input: 16 Output: 16	-	24 V DC Sink/Source (±common)	Transistor output: NPN 0.1 A/5 to 24 V	MIL connector	FP0-E32T	AFP03543

- Notes: 1) The relay output type expansion units come with a power cable (part number AFP0581). (The transistor output type needs no power cable.)
 2) The terminal block type relay output units have 2 terminal blocks (9 pins) made by Phoenix. Use a 2.5 mm wide screwdriver. Preferably use the specific terminal block screwdriver (part number AFP0806, Phoenix type code SZS 0.4 × 2.5 mm) or equivalent.
 3) The connector-type relay output units have 2 connectors made by Nihon Molex (Molex type code 51067-0900, 9 pins). Use the specific Molex connector press-fit tool (part number AFP0805, Nihon Molex type code 57189-5000) or equivalent.
 4) The transistor output units have a press-fit socket for wire-pressed terminal cable and contacts. Use the press-fit tool (part number AXY52000) for wire-pressed terminal cable.
 5) A PNP 0.1 A/24 V DC transistor output type is also available. When ordering it, please replace "T" in the end of product number for the NPN type with "P".

FP0 Intelligent Units

Product name	Specifications	Product number	Part number
FP0 Thermocouple unit	K, J, T, R thermocouple, Resolution: 0.1 °C	FP0-TC4	AFP0420
	K, J, T, R thermocouple, Resolution: 0.1 °C	FP0-TC8	AFP0421
FP0 Analog I/O unit	<Input specifications> Number of channels: 2 channels Input range: 0 to 5 V, -10 to +10 V (Resolution: 1/4000) 0 to 20 mA (Resolution: 1/4000)	FP0-A21	AFP0480
	<Output specifications> Number of channels: 1 channel Output range: -10 to +10 V (Resolution: 1/4000) 0 to 20 mA (Resolution: 1/4000)		
FP0 A/D Converter Unit	<Input specifications> Number of channels: 8 channels Input range: 0 to 5, -10 to +10 V, -100 to 100 mV (Resolution: 1/4000) 0 to 20 mA (Resolution: 1/4000)	FP0-A80	AFP0401
FP0 D/A Converter Unit	<Output specifications> Number of channels: 4 channels Output range: -10 to +10 V (Resolution: 1/4000) 4 to 20 mA (Resolution: 1/4000)	FP0-A04V	AFP04121
		FP0-A04I	AFP04123

FP0 Link Units

Product name	Specifications	Power supply voltage	Product number	Part number
FP0 CC-Link Slave unit	This unit is for making the FP0 function as a slave station of the CC-Link. Only one unit can be connected to the furthest right edge of the FP0 expansion bus. Note: Accuracy will change if an FP0 thermocouple unit is used at the same time. For details, please refer to the FP0 catalog or to the CC-Link Unit manual.	24 V DC	FP0-CCLS	AFP07943
FP0 I/O Link unit	This is a link unit designed to make the FP0 function as a station to MEWNET-F (remote I/O system).	24 V DC	FP0-IOL	AFP0732

Control FPCWIN GR for Windows

Product name	Type	Part number	Applicable PLC									
			FP-X	FPΣ	FP0 FP-e	FP0 10k	FP1*	FP2	FP2SH	FP-M*	FP3* FP10SH	
FPCWIN GR for Windows	English: Full type	CD-ROM for Windows	AFPS10520	A	A	A	A	A	A	A	A	A
	English: Small type	CD-ROM for Windows	AFPS11520	A	A	A	A	A	N/A	N/A	A	N/A
	English: Ver. up type	CD-ROM for Windows	AFPS10520R									
	Chinese	CD-ROM for Windows	AFPS10820	A	A	A	A	A	A	A	A	A
	Chinese: Ver. up type	CD-ROM for Windows	AFPS10820R									
	Korean	CD-ROM for Windows	AFPS10920									

*The production of FP1, FP-M, FP3/FP10SH has been discontinued. A: Available, N/A: Not available
 Note) FP-X compatible versions: Relay output type - Ver. 2.50 or later; Transistor output type - Ver. 2.70 or later

Control FPCWIN Pro (IEC61131-3 compliant Windows version software)

Product name	Type	Part number	Applicable PLC									
			FP-X	FPΣ	FP0 FP-e	FP0 10k	FP1*	FP2	FP2SH	FP-M*	FP3* FP10SH	
FPCWIN Pro for Windows	English: Full type	CD-ROM for Windows	AFPS50550	A	A	A	A	A	A	A	A	A
	English: Small type	CD-ROM for Windows	AFPS51550	A	A	A	A	A	N/A	N/A	A	N/A

*The production of FP1, FP-M, FP3/FP10SH has been discontinued. A: Available, N/A: Not available
 Note) FP-X compatible versions: Relay output type - Ver. 5.1 or later; Transistor output type - Ver. 5.3 or later

Related Products List

Programmable Display GT Series

Product name	Description				Part number
GT01 Main Unit 	STN monochrome LCD	5V DC	RS232C type	Black	AIGT0030B1
			RS422/RS485 type	Ash gray	AIGT0030H1
		24V DC	RS232C type	Black	AIGT0032B1
				Ash gray	AIGT0032H1
			RS422/RS485 type	Black	AIGT0030B
				Ash gray	AIGT0030H
GT01R Main Unit 	STN monochrome LCD	5V DC	RS232C type	Pure black	AIGT0230B1
			RS422/RS485 type	Silver	AIGT0230H1
		24V DC	RS232C type	Pure black	AIGT0230B
				Silver	AIGT0230H
			RS422/RS485 type	Pure black	AIGT0232B
				Silver	AIGT0232H
GT11 Main Unit 	STN monochrome LCD	24V DC	RS232C type	Black	AIGT2030B
			RS422/RS485 type	Ash gray	AIGT2030H
			Black	AIGT2032B	
			Ash gray	AIGT2032H	
GT21C Main Unit 	STN color LCD	24V DC	RS232C type	Black	AIGT2230B
			RS422/RS485 type	Silver	AIGT2230H
			Black	AIGT2232B	
			Silver	AIGT2232H	
GT32M Main Unit 	TFT monochrome LCD	24V DC	RS232C type	Pure black	AIG32MQ02D
			RS422/RS485 type	Silver	AIG32MQ03D
			Pure black	AIG32MQ04D	
			Silver	AIG32MQ05D	
GT32T0 Main Unit 	TFT color LCD	24V DC	RS232C type	Pure black	AIG32TQ02D
			RS422/RS485 type	Silver	AIG32TQ03D
			Pure black	AIG32TQ04D	
			Silver	AIG32TQ05D	
GT32T1 Main Unit (Ethernet and sound output function supported) 	TFT color LCD	24V DC	RS232C type	Pure black	AIG32TQ12D
			RS422/RS485 type	Silver	AIG32TQ13D
			Pure black	AIG32TQ14D	
			Silver	AIG32TQ15D	

Control CommX Ver. 1.3 (OCX for Communication)

Product name	Part number
Control CommX IBM printer port	AFW20011
Control CommX USB port	AFW20031

FP Memory Loader

Product name	Part number
Data non-hold type	AFP8670
Data hold type	AFP8671

FP Web-Server Unit

Product name	Part number
FP Web-Server unit	AFP0610
FP Web Configurator Tool	AFPS30510

PCWAY Ver. 2.7 (Operation Data Managing Software)

Product name	Part number
PCWAY USB port version	AFW10031
PCWAY Version upgrade	AFW10401

* Charged version upgrade for Ver. 2.0 to 2.6.

Key Unit

Economical type is available for secondary key.
The key unit is available for PCWAY and Control CommX.

Product name	Part number
Key unit USB port version	AFW1033

Specifications

1. General Specifications

Item	Description
Rated voltage	100 to 240 V AC (AC power), 24 V DC (DC power)
Operating voltage range	85 to 264 V AC (AC power), 20.4 to 28.8 V DC (DC power)
Service power output	C14: 24V DC/0.15A, C30 and C60: 24V DC/0.4A
Rush current	40 A or less (C14), 45 A or less (C30, C60) at 25°C (AC power) 12 A or less at 25°C (DC power)
Allowed momentary power off time	10 ms or more
Ambient temperature	0 to +55°C
Storage temperature	-40 to +70°C
Ambient humidity	10 to 95% RH (at 25 °C, non-condensing)
Storage humidity	10 to 95% RH (at 25 °C, non-condensing)
Breakdown voltage	Combined input/output terminals - Combined power and ground terminals, 2300 V AC ^{*1} 1 minute (AC power), 500 V AC ^{*1} 1 minute (DC power)
	Input terminals - Relay output terminals, 2300 V AC ^{*1} 1 minute
	Input terminals - Transistor output terminals, 500 V AC ^{*1} 1 minute
Insulation resistance	Power terminals - Ground terminals, 1500 V AC ^{*1} 1 minute (AC power), 500 V AC ^{*1} 1 minute (DC power)
	Combined input/output terminals - Combined power and ground terminals, 100 MΩ or higher (500 V DC using an insulation resistance meter)
	Input terminals - Output terminals, 100 MΩ or higher (500 V DC using an insulation resistance meter) Power terminals - Ground terminals, 100 MΩ or higher (500 V DC using an insulation resistance meter)
Vibration resistance	5 to 9 Hz, single amplitude 3.5 mm/9 to 150 Hz, constant acceleration 9.8 m/s ² , 1 sweep/min, 10 sweeps in each XYZ direction
Shock resistance	147 m/s ²
Noise immunity	1500 V [P-P] pulse width 50 ns, 1 μs (AC power), 500 V [P-P] pulse width 50 ns, 1 μs (DC power) (per noise simulator method) (power terminals)
Operating condition	No corrosive gas and no excessive dust
EC Directive Compliance Standard	Conforming to EN61131-2
Level of contamination	2
Over-voltage category	II

*1 Cutoff current 5 mA

2. Power Consumption, Weight

Product name	Part number	Current consumption	Weight
Control Unit	AFPX-C14○○	26W or less ^{*2}	Approx. 280g or less
	AFPX-C30○○	52W or less ^{*2}	Approx. 490g or less
	AFPX-C60○○	64W or less ^{*2}	Approx. 780g or less
Expansion I/O Unit	AFPX-E16○○	8W or less ^{*2}	Approx. 195g or less
	AFPX-E30○○	45W or less ^{*2}	Approx. 470g or less
Expansion FP0 adapter	AFPX-EFP0	0.24W or less ^{*3}	Approx. 65g
Input cassette	AFPX-IN8	1W or less ^{*2}	Approx. 25g
Output cassette	AFPX-TR8	1W or less ^{*2}	Approx. 25g
	AFPX-TR6P	1W or less ^{*2}	Approx. 25g
Pulse I/O cassette	AFPX-PLS	2W or less ^{*2}	Approx. 25g
Master memory cassette	AFPX-MRTC	2W or less ^{*2}	Approx. 20g
Analog input cassette	AFPX-AD2	2W or less ^{*2}	Approx. 25g
Analog I/O cassette	AFPX-A21	3W or less ^{*2}	Approx. 25g
Analog output cassette	AFPX-DA2	5W or less ^{*2}	Approx. 25g
Thermocouple input cassette	AFPX-TC2	1W or less ^{*2}	Approx. 25g
Communication cassettes	AFPX-COM1	2W or less ^{*2}	Approx. 20g
	AFPX-COM2		
	AFPX-COM3		
	AFPX-COM4		
	AFPX-COM5	3W or less ^{*2}	Approx. 25g
	AFPX-COM6	2W or less ^{*2}	Approx. 20g

*2 Power consumption by the AC power supply connected to the control unit

*3 Power consumption by the DC power supply connected to the expansion FP0 adapter

Please refer to the user manual and specifications for further details.

3. Controls Specifications

Item	Specifications	
Program method	Relay symbol method	
Control method	Cyclic operation method	
Program memory	Flash ROM built-in (no battery backup required)	
Program capacity	16 ksteps (C14), 32 ksteps (C30, C60)	
Operation processing speed	Basic instruction 0.32 μs/step	
Basic instructions	111	
Applied instructions	216	
External inputs (X)	1760 points ^{*4}	
External outputs (Y)	1760 points ^{*4}	
Internal relay (R)	4096 points	
Special internal relay (R)	192 points	
Link relay (L)	2048 points	
Timer/counter (T/C)	Total 1024 points: timer capable of counting (1 ms, 10 ms, 100 ms, 1 s) x 32767 Counter capable of counting 1 to 32767	
Data register (DT)	12285 words (C14), 32765 words (C30, C60)	
Link data register (LD)	256 words	
Special data register (DT)	374 words	
Index register (I0 to ID)	14 words	
Master control relay (MCR)	256 points	
Number of labels (LOOP)	256 labels	
Number of differentiations	Up to program capacity	
Number of stepladders	1000 stages	
Number of subroutines	500 subroutines	
Number of interruption programs	Relay output type: 15 programs (14 external, 1 constant) Transistor output type: 9 programs (8 external, 1 constant)	
High-speed counter ^{*5}	Built-in (Transistor output): single-phase 8 ch (50 kHz x 4 ch + 10 kHz x 4 ch) Built-in (Relay output): single-phase 8 ch (10 kHz x 8 ch) Pulse I/O cassette: single-phase 2 ch (80 kHz x 2 ch)	
Pulse output ^{*6}	Built-in (Transistor output): 100 kHz x 2 ch + 20 kHz x 2 ch Pulse I/O cassette: One unit (one axis) 100 kHz, or two units (two axes) 80 kHz	
Pulse catch input / interrupt input	Relay output type: Total 14 points (including the high-speed counter) Transistor output type: Total 8 points (including the high-speed counter)	
Periodical interrupt	0.5 ms to 30 s	
Potentiometer	2 points (0 to 1000) (C14, C30) 4 points (0 to 1000) (C60)	
Constant scan	Possible	
Real-time clock	Equipped (usable only when AFPX-MRTC is installed) ^{*7}	
Flash ROM backup ^{*9}	Backup by F12, P13 commands	Data register (32765 words)
	Auto-backup at power failure	Counter 16 points (1008 to 1023), Internal relay 128 points (R2470 to R255F), Data register 55 words
Battery backup	The memory allocated in the storage area by the system register (only when a battery is installed) ^{*8}	
Battery life (when no power is supplied)	Before installing AFPX-MRTC	C14: 1230 days (actual operation 10 years at 25°C) C30, C60: 990 days (actual operation 10 years at 25°C)
	After installing AFPX-MRTC	C14: 780 days (actual operation 10 years at 25°C) C30, C60: 680 days (actual operation 10 years at 25°C) (More than two batteries can be installed in C30 and C60. In this case, the battery life is extended several times)
Password	Capable (4 or 8 characters selectable)	
Self-diagnosis function	Watch dog timer, program syntax check	
Comment storage	Capable (328 KB) (backup battery not required)	
PLC link function	Max 16 units, link relay 1024 points, link register 128 words (No data transfer or remote programming)	
Rewriting in RUN mode	Capable	

*4 The actual usable number of points is restricted by the hardware.

*5 Specification at the rated input voltage of 24 V DC, 25°C. Frequency may be lower due to the voltage and temperature.

*6 Max frequency may vary by the method of operation. Please refer to the manual for details.

*7 Calendar accuracy at 0°C: 119 sec/month or less, 25°C: 51 sec/month or less, 55°C: 148 sec/month or less (Real-time clock requires a battery.)

*8 When data is stored in the storage area while the battery is not installed, the data is not cleared and the data value may be indefinite.

The same condition occurs when the battery is exhausted.

*9 The number of possible rewrites is 10,000 or less.

Specifications

4. Input Specifications (Control unit, Expansion unit and Add-on cassette)

Item	Description		
	Relay output (control unit and expansion unit)	Transistor output (control unit and expansion unit)	Add-on cassette (AFPX-IN8, AFPX-IN4T3)
Insulation method	Photo-coupler		
Rated input voltage	24 V DC		
Operating voltage range	21.6 to 26.4 V DC		
Rated input current	Approx. 4.7 mA (Control unit X0 to X7)	Approx. 8 mA (Control unit X0 to X3)	Approx. 3.5 mA
	Approx. 4.3 mA (Control unit X8 and after, Expansion unit)	Approx. 4.7 mA (Control unit X4 to X7)	
Input points per common	8 points/common (C14, E16)	16 points/common (C30, C60, E30)	8 points/common (AFPX-IN8), 4 points/common (AFPX-IN4T3)
	(Input power polarity either positive or negative)		
Min. ON voltage/ON current	19.2 V/3 mA	19.2 V/6 mA (Control unit X0 to X3) 19.2 V/3 mA (Control unit X4 and after, Expansion unit)	19.2V/3mA
Max. OFF voltage/OFF current	2.4 V/1 mA	2.4 V/1.3 mA (Control unit X0 to X3) 2.4 V/1 mA (Control unit X4 and after, Expansion unit)	2.4V/1mA
Input impedance	Approx. 5.1 kΩ (Control unit X0 to X7) Approx. 5.6 kΩ (Control unit X8 and after, Expansion unit)	Approx. 3 kΩ (Control unit X0 to X3) Approx. 5.1 kΩ (Control unit X4 to X7) Approx. 5.6 kΩ (Control unit X8 and after, Expansion unit)	Approx. 6.8 kΩ
Response time	OFF → ON	Control unit X0 to X7 0.6 ms or less: Normal input 50 μs or less: High-speed counter, pulse catch, interruption input setting *1	1.0 ms or less
		Control unit X8 and after, Expansion unit 0.6 ms or less	
	ON → OFF	Same as above	
Operating indicator	LED display		

*1 Specification at the rated input voltage of 24 V DC, 25°C.

5. Relay Output Specifications (Control units, Expansion units)

Item	Description
Output type	1a contact
Rated control capacity (Resistive load)	2 A 250 V AC, 2 A 30 V DC (8 A or less/common)
Output points per common	C14, E16: 1 point or 3 points/common, C30, E30: 1 point or 4 points/common, C60: 1, 2 or 4 points/common
Response time	OFF → ON
	ON → OFF
Life time	Mechanical
	Electrical
Surge absorber	None
Operating indicator	LED display

6. Transistor Output Specifications (Control unit, Expansion unit and Add-on cassette)

Item	Description	
	Control unit, Expansion unit	Add-on cassette (AFPX-TR8, AFPX-TR6P, AFPX-IN4T3)
Insulation method	Photocoupler	
Output type	Open collector	
Rated load voltage	NPN type: 5 to 24 V DC, PNP type: 24 V DC	24 V DC
Load voltage allowable range	NPN type: 4.75 to 26.4 V DC, PNP type: 21.6 to 26.4 V DC	21.6 to 26.4 V DC
Max. load current	0.5 A	NPN type: 0.3 A, PNP type: 0.5 A
Max. inrush current	1.5 A	
Output points per common	C14: 6 points/common, E16: 8 points/common, C30, C60, E30: 8 or 6 points/common	TR8: 8 points/common, TR6P: 6 points/common, IN4T3: 3 points/common
OFF state leakage current	1 μA or less	
ON state voltage drop	0.3 V DC or less	1.5 V DC or less
Response time	OFF → ON	1 ms or less*2
	ON → OFF	1 ms or less*2
Voltage range for external power supply	21.6 to 26.4 V DC	—
Surge absorber	Zener diode	
Operating indicator	LED display	

*2 Please refer to the user manual for Y0 to Y7 of the transistor output type.

■ FP-X Control Unit Dimensions (Unit: mm)

●AFPX-C14** (The same dimensions apply to the expansion I/O unit AFPX-E16**)

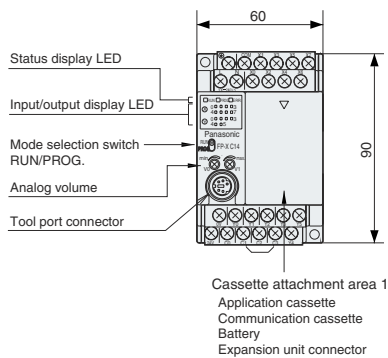

Dimensions when add-on cassettes (function and communication) are installed

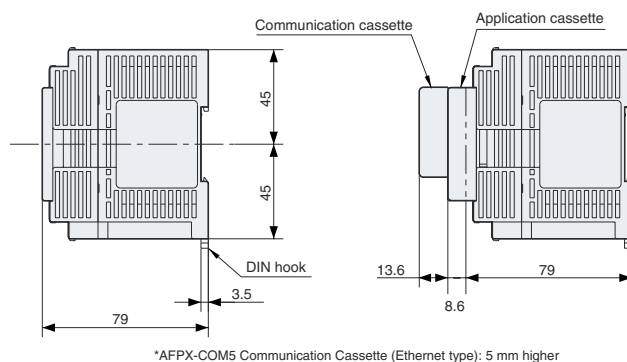

●AFPX-C30** (The same dimensions apply to the expansion I/O unit AFPX-E30**)

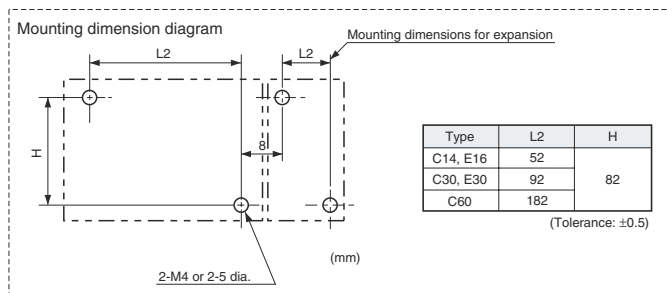
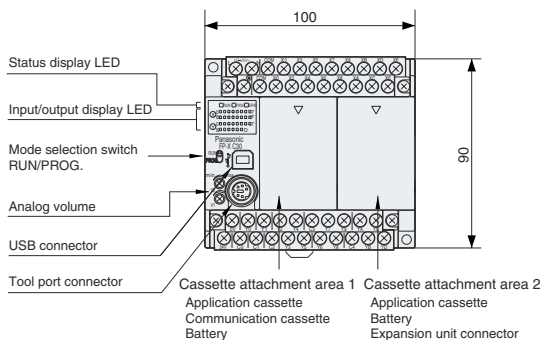

●AFPX-C60**

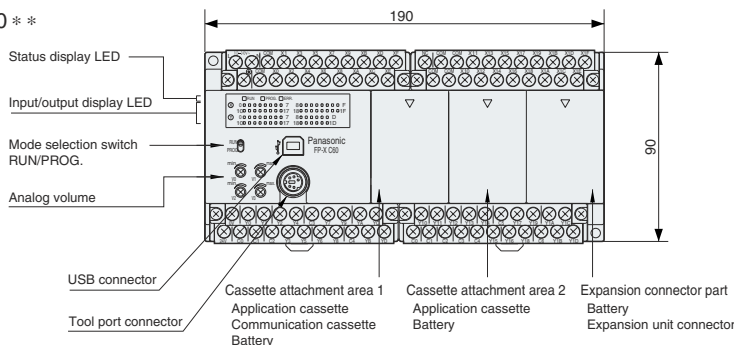

■ FP-X Expansion FP0 Adapter Dimensions (Unit: mm)

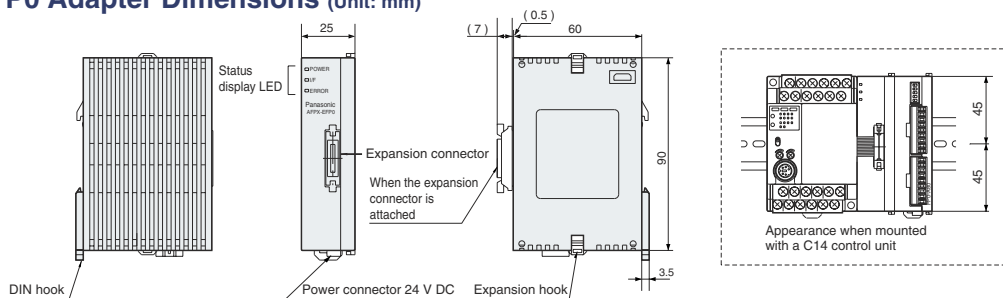

These materials are printed on ECF pulp.
These materials are printed with earth-friendly vegetable-based (soybean oil) ink.



Please contact

Matsushita Electric Works, Ltd.

Automation Controls Business Unit

■ Head Office: 1048, Kadoma, Kadoma-shi, Osaka 571-8686, Japan

■ Telephone: +81-6-6908-1050 ■ Facsimile: +81-6-6908-5781

<http://www.mew.co.jp/ac/e>



All Rights Reserved © 2007 COPYRIGHT Matsushita Electric Works, Ltd.