

- Contatores tripolares e tetrapolares desde 6 até 630A
- De acordo com normas IEC60947-4-1, IEC60947-5-1, UL508 e JEM1038
- Bobinas para CA e CC
- Certificado UL e CE

- 3 and 4 poles magnetic contactors from 6 to 630A
- According to IEC60947-4-1, IEC60947-5-1, UL508 and JEM1038
- AC and DC coils
- UL and CE approved

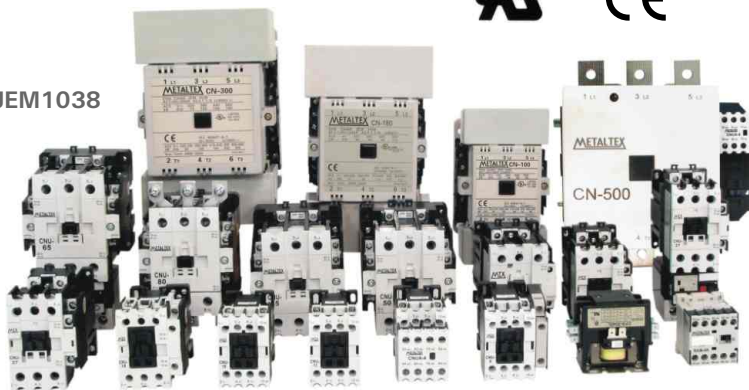

### Chave de código / How to order

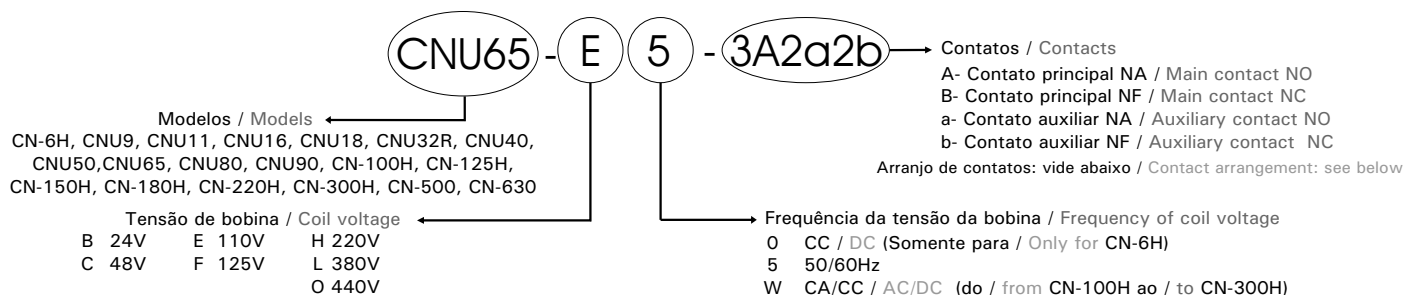

### Características dos contatos / Contacts characteristics















Modelo / Models	CN-6H	CNU9 CNU11 CNU16	CNU18	CNU32R CNU40	CNU50	CNU65 CNU80 CNU90	CN-100H CN-125H CN-150H CN-180H CN-220H CN-300H	CN-500 CN-630
Arranjo dos contatos / Contacts arrangement	3A1a 3A1b	3A1a 3A1b 4A	3A1a1b	3A1a1b	3A2a2b	3A2a2b	3A2a2b	3A2a2b + 1a
Vida elétrica / Electrical life	10 <sup>6</sup> operações / operations				10 <sup>5</sup> oper.	10 <sup>6</sup> operações / operations		
Vida mecânica / Mechanical life	10 <sup>7</sup> oper.	10 <sup>6</sup> operações / operations						
Capacidade de fechamento / Make capacity*	10 x Ie** (A)							
Capacidade de abertura / Brake capacity*	8 x Ie** (A)							
Tensão de isolamento contatos principais / Insulation voltage main contacts - IEC/UL	660/600V				1000/600V			
Tensão de operação nominal contatos principais / Rated operation voltage main contacts - IEC/UL	660/600V				690/600V			
Grau de proteção / Protection degree	IP20							
Temperatura de armazenamento / Storage temperature - IEC/UL	-40°C +80°C							
Temperatura de operação / Operating temperature	-20°C +55°C							
Umidade relativa / Relative Humidity	45 ~ 85%RH (sem condensação / non dew)							
Altitude de operação / Operating altitude	Abaixo de / Below 200m							
Posição de operação / Operating position	±30°							

\*Condição de sobrecarga / Overload condition \*\*Ie: Corrente nominal (vide especificações) / Rated current, (see specifications)



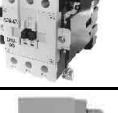

### Características da bobina / Coil characteristics

Modelo / Model	CN-6H	CNU9 a/to CNU16	CNU18	CNU32R	CNU40	CNU50, CNU65 CNU80, CNU90	CN-100H CN-125H	CN-150H CN-180H	CN-220H CN-300H	CN-500	CN-630		
Tensão de acionamento max. Pick-up voltage max.	75%Vn	70%Vn	75%Vn	75%Vn	75%Vn	75%Vn	75%Vn	75% Vn	75% Vn	75% Vn	75% Vn		
Consumo Consumption	CA AC	Partida / Inrush (VA)	27	70	70	150	215	280	300	700	300	1100	1650
		Acionada / Sealed (VA)	5	12	12	15	27	32	63	88	63	18	22
	CA/CC AC/DC	Partida / Inrush (VA)	30	150	150	300	300	400	250	400	400	—	—
		Acionada / Sealed (VA)	2	12	12	5	5	5	4	7	4,5	—	—
CC / DC	Acionada / Sealed (VA)	3,3	—	—	—	—	—	—	—	—	—	—	

## Especificações / Specifications

Modelo Model	Ith A IEC (UL)	Tensão VCA / VAC	Capacidade / Capacity AC3			Capacidade / Capacity AC4			AC-6a	AC-6b		Aparência Appearance
			le (A)	P (KW)	P (HP)	P (KW)	le (A)	C.P.H. V.E.		le (A)	KVAR	
CN-6H	20 (20)	110 1Ø	10,5	0,55	0,75	-	-	-	-	-	-	
		220 1Ø	10	1,1	1,5	-	-	-	-	-	-	
		220 3Ø	10,1	2,2	3	2,2	10,1	600	-	2,2	-	
		380 3Ø	9	4	5	4	9	-	3	3,8	6	
		440 3Ø	8	4	5	4	8	30000	-	4,4	-	
CNU9	25 (24)	110 1Ø	10,5	0,55	0,75	-	-	-	-	-	-	
		220 1Ø	10,5	1,1	2	-	-	-	-	-	-	
		220 3Ø	11,5	2,5	3	2,5	11	1200	-	2,7	-	
		380 3Ø	11	4	5	4	11	-	4	4,7	7	
		440 3Ø	9	4	5	4	9	80000	-	5,4	-	
CNU11	25 (24)	110 1Ø	10,5	0,55	1	-	-	-	-	-	-	
		220 1Ø	10,5	1,1	2	-	-	-	-	-	-	
		220 3Ø	12	3	5	3	12	1200	-	3	-	
		380 3Ø	12	5,5	7,5	5,5	12	-	4	5,3	8	
		440 3Ø	11	5,5	7,5	5,5	11	80000	-	6,1	-	
CNU16	25 (32)	110 1Ø	13,5	0,75	1,5	-	-	-	-	-	-	
		220 1Ø	14	1,5	3	-	-	-	-	-	-	
		220 3Ø	16	4	5	4	16	1200	-	4,4	-	
		380 3Ø	16	7,5	10	7,5	16	-	6	7,6	12	
		440 3Ø	15	7,5	10	7,5	15	60000	-	8,8	-	
CNU18	35 (35)	110 1Ø	19,5	1,1	2	-	-	-	-	-	-	
		220 1Ø	20,5	2,2	3	-	-	-	-	-	-	
		220 3Ø	23	5,5	7,5	5,5	23	1200	-	6,4	-	
		380 3Ø	22	11	15	11	22	-	9	11,1	17	
		440 3Ø	21	11	15	11	21	40000	-	12,8	-	
CNU32R	60 (50)	110 1Ø	35	1,5	2	-	-	-	-	-	-	
		220 1Ø	35	3,7	5	-	-	-	-	-	-	
		220 3Ø	35	9	12	9	32	1200	-	10,1	-	
		380 3Ø	32	15	20	15	32	-	14	17,5	27	
		440 3Ø	32	15	20	15	32	30000	-	19,0	-	
CNU40	60 (60)	110 1Ø	43	2,2	3	-	-	-	-	-	-	
		220 1Ø	43	5,9	7,5	-	-	-	-	-	-	
		220 3Ø	44	11	15	9	37	1200	-	11,8	-	
		380 3Ø	40	20	27	19	37	-	16	20,4	31	
		440 3Ø	40	22	30	19	36	30000	-	23,6	-	
CNU50	70 (72)	110 1Ø	48	3	5	-	-	-	-	-	-	
		220 1Ø	48	6	15	-	-	-	-	-	-	
		220 3Ø	55	15	20	11	45	600	-	13,5	-	
		380 3Ø	55	25	35	22	45	-	18	23,3	35	
		440 3Ø	52	30	40	22	40	30000	-	30,4	-	
CNU65	80 (85)	110 1Ø	50	3	5	-	-	-	-	-	-	
		220 1Ø	50	7	15	-	-	-	-	-	-	
		220 3Ø	65	18,5	25	15	52	600	-	15,2	-	
		380 3Ø	64	30	40	25	52	-	20	26,3	40	
		440 3Ø	64	37	50	25	50	30000	-	28	-	
CNU80	100(104)	110 1Ø	60	4	7,5	-	-	-	-	-	-	
		220 1Ø	55	7,5	15	-	-	-	-	-	-	
		220 3Ø	75	22	30	19	65	600	-	18,6	-	
		380 3Ø	72	37	50	30	64	-	25	32	49	
		440 3Ø	70	40	50	33	63	30000	-	35	-	
CNU90	135(130)	220 3Ø	85	25	35	25	85	-	-	27	-	
		380 3Ø	85	45	60	45	85	300	-	46	-	
		440 3Ø	85	51	70	51	85	-	36	52	71	
		500 3Ø	80	55	75	55	80	30000	-	61	-	
		660 3Ø	65	55	75	55	65	-	-	-	-	
CN-100H	135(130)	220 3Ø	105	30	40	25	85	-	-	31,4	-	
		380 3Ø	105	55	75	45	85	300	-	54,3	82	
		440 3Ø	100	60	80	45	76	-	-	62,8	-	
		500 3Ø	93	65	85	51	75	30000	-	71,4	-	
		660 3Ø	75	65	85	51	57	-	-	-	-	
CN-125H	150(150)	220 3Ø	126	37	50	30	96	-	-	35,5	-	
		380 3Ø	115	60	80	50	95	300	-	61,3	93	
		440 3Ø	109	63	85	55	90	-	-	70,9	-	
		500 3Ø	105	75	100	59	85	30000	-	80,6	-	
		660 3Ø	85	75	100	59	66	-	-	-	-	
CN-150H	200(200)	220 3Ø	150	45	60	37	130	-	-	43,6	-	
		380 3Ø	147	80	110	65	130	300	-	75,3	114	
		440 3Ø	131	80	110	65	120	-	-	87,2	-	
		500 3Ø	129	90	125	65	100	30000	-	-	-	
		660 3Ø	107	100	136	65	76	-	-	-	-	

## Especificações / Specifications

Modelo Model	Ith A IEC (UL)	Tensão VCA / VAC	Capacidade / Capacity AC3			Capacidade / Capacity AC4			AC-6a	AC-6b		Aparência Appearance
			le (A)	P (KW)	P (HP)	P (KW)	le (A)	C.P.H. V.E.		le (A)	KVAR	
CN-180H	240(240)	220 3ø	182	55	75	45	160	300	70	52,7	138	
		380 3ø	179	95	125	45	160			91		
		440 3ø	178	110	150	80	140			105,4		
		500 3ø	156	110	150	80	120	30000	-	119,8	-	
		660 3ø	118	110	150	80	92	-	-	-	-	
CN-220H	260(260)	220 3ø	225	63	85	55	190	300	84	63,2	166	
		380 3ø	225	120	160	90	180			109,1		
		440 3ø	220	132	180	90	160			126,4		
		500 3ø	190	132	180	90	130	30000	-	143	-	
		660 3ø	140	132	180	90	102	-	-	-	-	
CN-300H	350(350)	220 3ø	300	90	120	65	220	300	99	74,3	195	
		380 3ø	300	160	220	110	220			128,4		
		440 3ø	300	160	220	110	190			148,7		
		500 3ø	250	160	220	110	170	30000	-	168	-	
		660 3ø	220	200	270	110	126	-	-	-	-	
CN-500	700	220 3ø	500	150	200	150	500	300	184	138	364	
		380 3ø	500	257	350	220	360			239		
		440 3ø	430	257	350	220	360			262		
		500 3ø	410	280	380	220	310	30000	-	314	-	
		660 3ø	355	355	450	220	235	-	-	-	-	
CN-630	750	220 3ø	630	220	270	200	630	300	-	177	466	
		380 3ø	630	335	450	250	400			306		
		440 3ø	600	375	500	250	400			335		
		500 3ø	525	375	500	250	310	30000	236	403	-	
		660 3ø	460	450	610	250	274	-	-	-	-	

A- Corrente nominal/Nominal current (Ie) / V- Tensão nominal/Nominal voltage (Ue) / C.P.H.- Comutações por hora/Switchings per hour / V.E.- Vida elétrica/Electrical life

## Arranjos de contatos / Contact arrangements

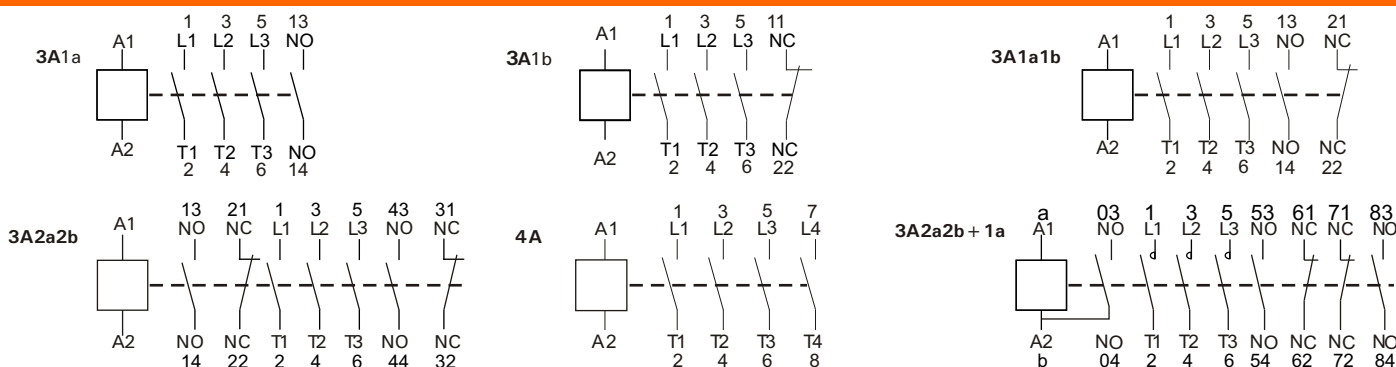

## Blocos de contatos auxiliares / Auxiliary contact blocks

Tipo / Type	Arranjo dos contatos / Contact arrangement	Montagem / Mounting	Uso com / Suitable for	Dimensões / Dimensions (mm)	
CNA-111S	1NA/NO + 1NF/NC	Lateral / Side	CNU9 ~ CNU40	70,3x65x12	
CNUA-2□□	02 : 2NF/NC 11 : 1NA/1NO + 1NF/1NC	Frontal / Top	CNU9 ~ CNU90	46x24x34,1	
CNA-2□□M	20 : 2NA/2NO		CN-6H / RAM4	31x30,8x30	
CNUA-4□□	22 : 2NA/2NO + 2NF/2NC 31 : 3NA/3NO + 1NF/1NC	Frontal / Top	CNU9 ~ CNU90	46x44,5x34,1	
CNA-4□□M	13 : 1NA/1NO + 3NF/3NC		Frontal / Top	CN-6H RAM4	31x45x30
	04 : 4NF/4NC				
	40 : 4NA/4NO				

## Especificações dos contatos auxiliares / Auxiliary contact characteristics

Tensão de isolamento / Rated insulation voltage (Ui) IEC/UL (V)		690/600	
Tensão de operação nominal / Rated operational voltage (Ue) IEC/UL (V)		690/600	
Corrente térmica CA/CC Thermal current AC/DC (Ith) (A)		10/2,5	
Código UL da capacidade / Contact rating code designation UL		A600 Q300	
Corrente de operação nominal / Rated operational current (A) IEC 60947-5-1 UL 508	AC-15 / A600	120V	6
		240V	3
		380V	1,9
		480V	1,5
		500V	1,4
	DC-13 / Q300	600V	1,2
		125V	0,55
		250V	0,27

**Acessórios / Accessories**



**Bobinas / Coils**

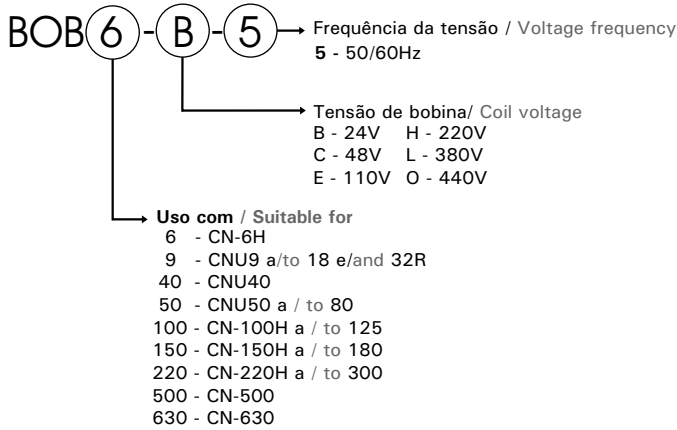

CSS-1/2



CSS-3

**Supressor / Surge suppressor**

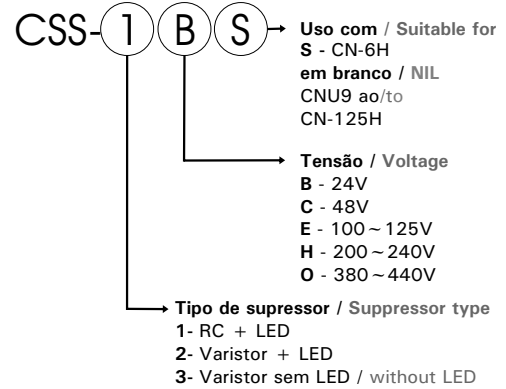

Dimensões / Dimensions: **CSS-1/2** 61,2 X 35 X 34,6 mm  
**CSS-3** 28 x 26 x 12 mm



**Drive de bobina / Coil drive**

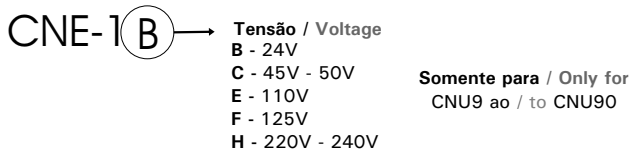

Este drive ligado a um contator CA permite que este seja acionado por uma tensão CC ou CA.  
This drive used with an AC contactor allows it to be applied to DC or AC voltage.

Dimensões / Dimensions: 43 X 45 X 44,2 mm



**Intertravamento mecânico / Mechanical interlock**

Modelo / Model	Uso com / Suitable for	Contatos / Contacts	Dimensões / Dimensions
<b>CNI-6</b>	CN-6H, RAM-4	-	91,3 x 25,2 x 11,07
<b>CNI-18</b>	CNU9 ao / to CNU90	2NF / 2 NC	47,9 x 62 x 10
<b>CI-35</b>	CNU40 ao / to CNU80	-	50,8 x 42,7 x 9,53
<b>CNI-100</b>	CN-100H ao / to CN-300H	-	66,1 x 66,25 x 12,4

**Contatores: dimensões e peso / Contactors: dimensions and weight**

Modelo / Model	Dimensões / Dimensions (mm)	Peso / Weight (KG)
<b>CN-6H</b>	58 X 45,1 X 54	0,18
<b>CNU9 / CNU11 / CNU16</b>	70 X 45 X 82	0,3
<b>CNU18 / CNU32R</b>	72 X 55 X 92	0,4
<b>CNU40</b>	99 X 69 X 111,7	0,9
<b>CNU50 / CNU65 / CNU80</b>	150 X 93 X 123	1,3
<b>CN-100H / CN-125H</b>	142 X 100 X 133	1,9
<b>CN-150H</b>	168 X 130,4 X 157,5	4,1
<b>CN-180H</b>	168 X 130,4 X 157,5	4,1
<b>CN-220H / CN-300H</b>	210 X 146 X 183,2	6,7
<b>CN-500H</b>	233 X 238 X 232	10,8
<b>CN-630H</b>	309 X 304 X 255	17,5

## Relés térmicos / Thermal overload relays



RHU-5



RHU-10



RHU-80



RHN-180

## Especificações / Specifications

	RHU-5	RHU-10	RHU-80	RHN-180
Tensão de isolamento nominal / Insulation voltage (Ui)	UL 600V IEC 690V			
Faixa de corrente / Current set range	Veja tabela abaixo / See table below			
Funções / Functions	Proteção contra falta de fase e sobrecarga / Open phase and overload protection Compensação da temperatura / Temperature compensated Função de teste / Test (STOP) function			
Modo de reset / Reset mode	Automático, manual / Automatic, manual			
Contatos / Contacts	1NA + 1NF / 1NO + 1NC			
Faixa de compensação da temperatura / Temperature compensation range	-5° ~ 40°C			
Classe de disparo / Trip class	10A			
Dimensões / Dimensions (mm)	45 x 53 x 60	145 x 52 x 72	156 x 87 x 94	100 x 102 x 105

## Modelos / Types

Modelo / Models	Faixa de corrente / Current range (A)	Uso com / Suitable for
RHU-5A/1,6A	1,1-1,6	CN-5H, CN-6H e / and RAM
RHU-5A/2A	1,4-2	CN-5H, CN-6H e / and RAM
RHU-5A/3,2A	2,3-3,2	CN-5H, CN-6H e / and RAM
RHU-5A/4A	2,9-4	CN-5H, CN-6H e / and RAM
RHU-5A/6,3A	4,5-6,3	CN-5H, CN-6H e / and RAM
RHU-5A/10A	7,2-10	CN-5H, CN-6H e / and RAM
RHU-10A1/2,5A	1,8-2,5	CNU9, CNU11, CNU16, CNU18 e / and CNU32R
RHU-10A1/4A	2,9-4	CNU9, CNU11, CNU16, CNU18 e / and CNU32R
RHU-10A1/4,8A	3,5-4,8	CNU9, CNU11, CNU16, CNU18 e / and CNU32R
RHU-10A1/6,3A	4,5-6,3	CNU9, CNU11, CNU16, CNU18 e / and CNU32R
RHU-10A1/7,5A	5,5-7,5	CNU9, CNU11, CNU16, CNU18 e / and CNU32R
RHU-10A1/10A	7,2-10	CNU9, CNU11, CNU16, CNU18 e / and CNU32R
RHU-10A1/16A	11,3-16	CNU9, CNU11, CNU16, CNU18 e / and CNU32R
RHU-10A1/12,5A	9-12,5	CNU9, CNU11, CNU16, CNU18 e / and CNU32R
RHU-10A1/20A	15-20	CNU9, CNU11, CNU16, CNU18 e / and CNU32R
RHU-10A1/25A	21-25	CNU9, CNU11, CNU16, CNU18 e / and CNU32R
RHU-10A1/30A	24,5-30	CNU9, CNU11, CNU16, CNU18 e / and CNU32R
RHU-80A2/25A	17-25	CNU-40
RHU-80A2/36A	24-36	CNU-40
RHU-80A2/47A	35-47	CNU-40
RHU-80A3/36A	24-36	CNU50, CNU65, CNU80 e / and CNU90
RHU-80A3/47A	35-47	CNU50, CNU65, CNU80 e / and CNU90
RHU-80A3/60A	45-60	CNU50, CNU65, CNU80 e / and CNU90
RHU-80A3/75A	58-75	CNU50, CNU65, CNU80 e / and CNU90
RHU-80P/75A	58-75	Trilho DIN / DIN rail
RHU-80P/90A	72-90	Trilho DIN / DIN rail
RHU-80P/97A	77-97	Trilho DIN / DIN rail
RHN-180A1/95A	65-95	CN-100, CN-125
RHN-180A1/125A	85-125	CN-100, CN-125
RHN-180A2/160A	110-160	CN-150
RHN-180A3/185A	125-180	CN-180

## Acessório para montagem em trilho DIN / DIN rail assembly accessory



### RP-10

Uso em conjunto com RHU-10A1 /  
To use with RHU-10A1.

Dimensões / Dimensions: 75 X 72 X 45 mm